



Chapter 10. RDM Scanner

OTCnet Participant User Guide

(This page intentionally left blank)

Audience and Overview

Audience

The intended audience for the *RDM Scanner Appendix* includes:

- Check Capture Administrator (CCA)
- Check Capture Supervisor (CCS)
- Check Capture Lead Operator (CCLO)
- Check Capture Operator (CCO)

Overview

Welcome to *RDM Scanner Appendix*. This chapter contains information on:

- How to install and use EC7000i* series and EC9100i series scanners
- How to install and use EC9600i series and EC9700i series scanners

* Note: OTCnet currently does not support EC7500i series

(This page intentionally left blank)

EC7000i and EC7500i Series Scanners User Guide

January 2018

Copyright ©2018 by RDM Corporation.

All rights reserved. No part of this publication may be reproduced, stored in a retrieval system, or transmitted, in any form or by any means, electronic, mechanical, photocopy, recording, or otherwise, without the prior written permission of RDM Corporation.

Trademarks

RDM, ITMS, Simply Deposit, Simply Deposit Mobile, Dynamic Decisioning Portal, DepositWatch+, QCX, QCV, EC6000i, EC7000i, EC7500i, EC9000i, EC9100i, and EC9600i are trademarks or registered trademarks of RDM Corporation. All other brands and their products are trademarks or registered trademarks of their respective holders and should be noted as such.

Disclaimer

RDM Corporation makes no warranty with respect to the adequacy of this documentation, programs, or hardware that it describes for any particular purpose or with respect to the adequacy to produce a particular result. In no event shall RDM Corporation be held liable for special, direct, indirect, or consequential damages, losses, cost, charges, claims, demands, or claim for lost profits, fees, or expenses of any nature or kind.

RDM Corporation

www.rdmcorp.com

End-User/Customer Agreement

Please read the end-user/customer agreement regarding software license and warranty terms during the installation of the application.

Compliance statements

FCC Compliance Statement

This equipment has been tested and found to comply with the limits for a Class A digital device, pursuant to Part 15 of the FCC rules. These limits are designed to provide reasonable protection against harmful interference when the equipment is operated in a commercial environment. This equipment generates, uses, and can radiate radio frequency energy and, if not installed and used in accordance with the instruction manual, may cause harmful interference to radio communications. Operation of this equipment in a residential area is likely to cause harmful interference in which case the user will be required to correct the interference at his own expense.

Warning: Changes or modifications not expressly approved by RDM could void the user's authority to operate the equipment.

All units covered by this manual have no user-serviceable parts inside. In the event repairs are ever needed to any RDM product, they should be performed by RDM Corporation or an authorized representative of RDM Corporation. For information please contact RDM Corporation,

619A Kumpf Drive, Waterloo, Ontario, Canada N2V 1K8, at 1-800-567-6227, or RDM's US service agent below.

US Service Agent
William Buser
(703) 286-5734
bbuser@deluxe.com

Contents

- Compliance statements..... 3
 - FCC Compliance Statement 3
- Contents 4
- Introduction..... 6
 - About this guide 6
 - Requirements 6
 - Recommendations 6
 - EC7000i and EC7500i models and features 7
 - EC7000i..... 7
 - EC7500i..... 7
 - Model and serial number..... 8
- Setting up the EC7000i or EC7500i 9
 - Choose a location 9
 - Unpack the shipping box..... 9
 - Inspect the scanner’s features 9
 - Inside EC7000i and EC7500i series scanners..... 11
 - Connection ports 11
 - Insert the franker cartridge 12
 - Connect to a telephone line 13
 - Connect the power cord 14
 - Drivers and software 14
 - Install the receipt printer paper roll..... 14
- Operating the scanner..... 15
 - Preparing checks 15
 - Feeding checks 15
 - Swiping magnetic stripe cards 15
- Status signals for EC7000i and EC7500i..... 16
 - EC7000i light signals and beeps..... 16
 - Startup..... 16
 - Document scanning and processing 16

EC7500i light signals and beeps..... 17

 Start up..... 17

 Document scanning and processing 17

 A Typical Document Processing / LED Cycle 17

Cleaning your scanner 18

 Cleaning the scanner with the RDM ScannerCare application 18

 Manual cleaning 19

 Cleaning the imaging camera glass 21

Troubleshooting 22

 Scanner does not respond 22

 Scanner modem cannot connect to the telephone line 22

 The check feeder does not function properly 23

 Card transactions do not function properly 23

Specifications 24

 Accessories and consumables..... 25

Appendix A 26

 Startup 26

 Document scanning and processing 26

Warranty Information..... 27

 LIMITED WARRANTY: 27

 WARRANTY SPECIFICS:..... 28

Introduction

The RDM EC7000i and EC7500i series scanners provide affordable functionality in a compact and efficient design. Featuring RDM's industry leading Progressive MICR Method and imaging technology the EC7000i and EC7500i series scanners deliver optimum MICR read rates and image quality. In addition, all EC7000i and EC7500i series scanners include a franker cartridge to comply with various payment industry guidelines.

With several models and feature options to choose from, the RDM EC7000i and EC7500i series scanners are an ideal fit for payment applications such as remote deposit capture, healthcare POS, retail POS, and walk-in bill payments.

About this guide

This guide describes the EC7000i and EC7500i series scanners, some basic operations, and how to maintain your scanner. For instructions on how to use your scanner to scan documents with your computer or credit card terminal, contact your solution provider.

Requirements

The EC7000i and the EC7500i scanners are for indoor use only. Keep the scanners dry and avoid areas of high humidity.

Do not remove any parts other than the areas specified in this guide. Removing parts other than the areas specified in this guide will void the warranty.

When you are working inside the scanner, such as when you are replacing the franker cartridge, make sure the scanner is disconnected.

Recommendations

Record all distributor contact information for future reference.

Save the original box and packing material. Reuse them if the unit must be shipped to a new location or returned for service.

Position the unit so that the operator has easy access to the check path and a clear view of the LED. Do not put the unit close to a heat source, in direct sunlight, or close to any device that can emit electromagnetic interference, such as a computer monitor or power adapter.

EC7000i and EC7500i models and features

The EC7000i and EC7500i series scanners are available in several optional model configurations. All models ship with a franker cartridge.

All scanner models can also be licensed to perform optical character recognition (OCR) on documents with machine printed text (remittances, pay stubs). This can be used with different applications such as walk-in bill payment. You can tell if your scanner is licensed for OCR by the label on the bottom of the scanner.

The following table lists the available EC7000i and EC7500i models and their optional features.

EC7000i

Model	Description
EC7011f	Single-feed scanner.
EC7014f	Single-feed scanner with a modem.
EC7111f	Single-feed scanner with MSR

EC7500i

Model	Description
EC7501f	Single-feed scanner.
EC7502f	Single-feed scanner with MSR.
EC7504f	Single-feed scanner with MSR and thermal printer.
EC7511f	Single-feed scanner.
EC7512f	Single-feed scanner with MSR.

Model and serial number

To locate the model and serial number of your scanner, carefully turn your scanner over to view the label affixed to the bottom.



Note: this guide is for EC series scanners with serial numbers beginning with 24 and higher. If your scanner's serial number begins with 23 or lower, you should download the appropriate guide from RDM's website, www.rdmcorp.com/support

Setting up the EC7000i or EC7500i

To set up the EC7000i and the EC7500i, follow these steps.

Choose a location

Locate your scanner in a place that:

- Has a flat surface, such as a countertop or table.
- Is convenient for the scanner operator.
- Offers adequate ventilation and protection from elements such as heat, dust, oil, or moisture.
- Is close to a telephone line (depending on your unit) and power connections.

NOTE: Before unpacking the box, examine it for damage received during shipping. If the scanner, or any component, appears damaged, do not use it. File a claim with the shipping company and contact your distributor.

Unpack the shipping box

1. Open the top of the box.
2. Remove and unwrap the items. Lift the scanner out of the box from the bottom of the scanner.
3. Save the box and wrapping for future use.

Your EC7000i or EC7500i product package includes the following:

- The scanner
- Power adapter
- Telephone cord (if the scanner includes a modem)
- Franker cartridge
- USB cable
- Thermal receipt paper roll (if the scanner includes a printer)

Inspect the scanner's features

EC7000i and EC7500i scanners look very similar, but some scanners include a magnetic stripe reader (MSR) and the EC7504f includes a receipt printer. The illustrations below show the basic scanner (type A), and a scanner with a magnetic stripe reader and printer (type B). We'll use type A throughout this manual for consistency.

For more information on scanner models and features, see [Model and serial number](#).

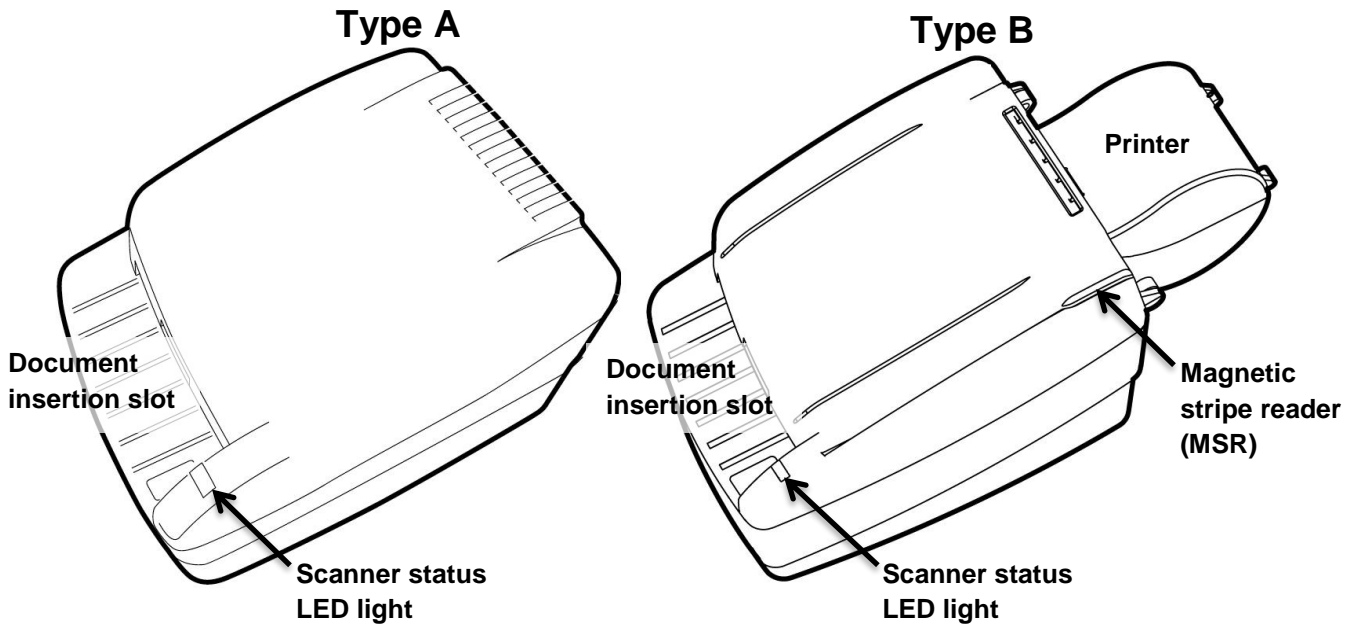

Inside EC7000i and EC7500i series scanners

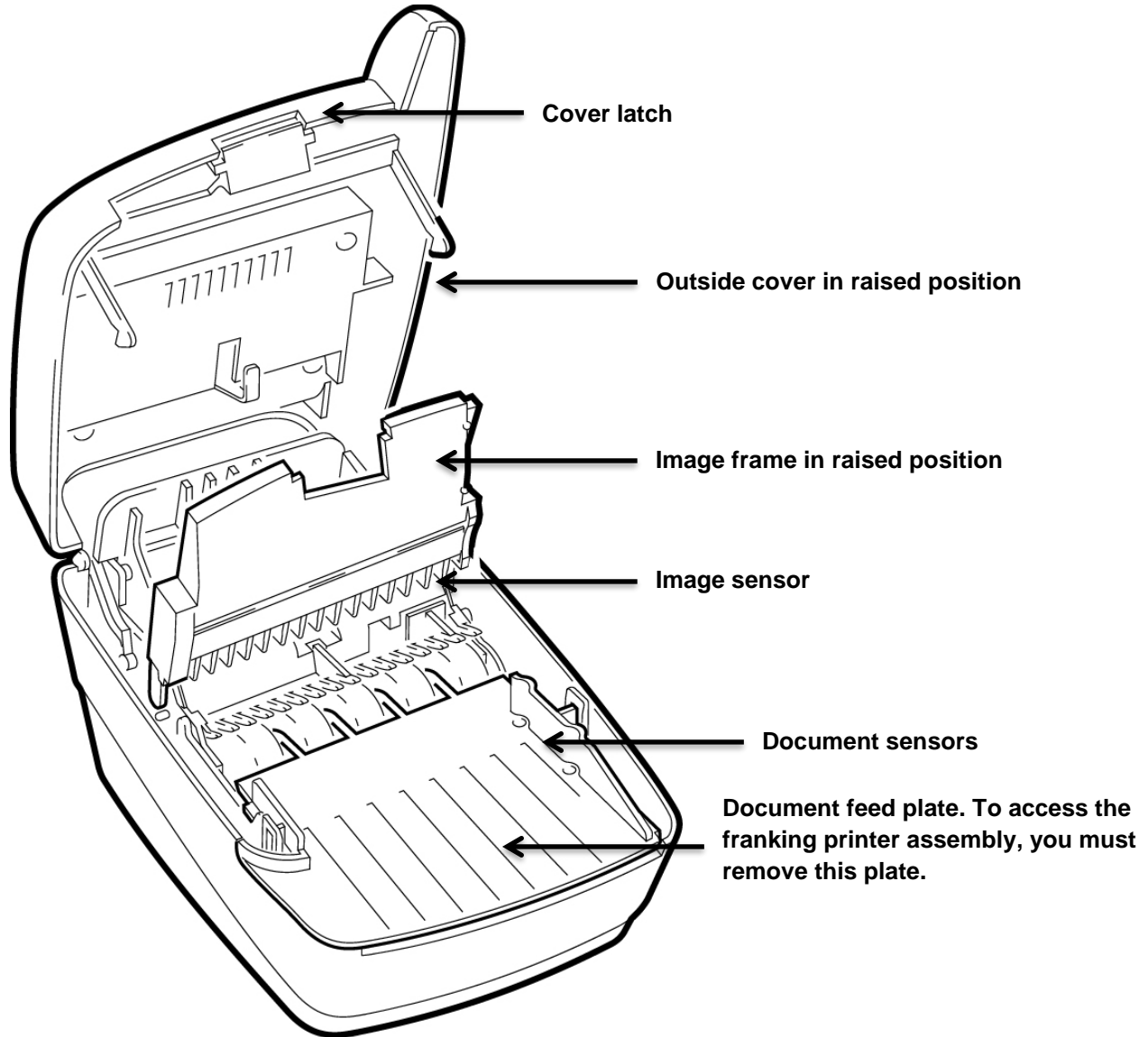

Connection ports

The EC7000i and EC7500i have different configurations of connection ports based on optional features. These configurations are set and programmed by the distributor (reseller) to suit your unique needs.

The following diagrams show the possible ports for EC7000i and EC7500i scanners:

EC7000i ports

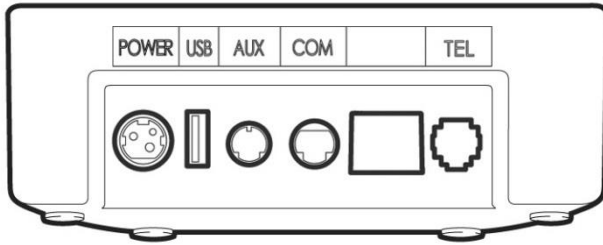

The following table describes the scanner ports, from left to right:

Power (Red)	Connect the power adaptor to this port.
USB (Orange)	Use this port to connect to a PC.
AUX (Yellow)	Use this port to connect optional peripheral devices such as a pass-through printer.
COM (Green)	Use this port to connect to a PC or terminal.
TEL (Purple)	Use this port to connect to a telephone line. This port is only included on scanners with a modem.

EC7500i ports

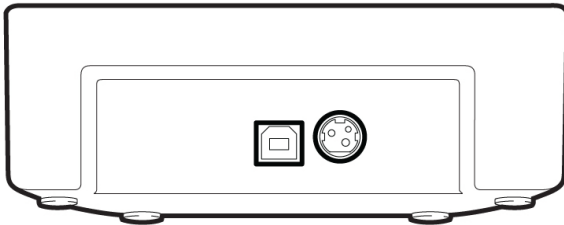

The following table describes the scanner ports, from left to right:

USB (Left)	Use this port to connect to a PC.
Power (Right)	Connect the power adaptor to this port.

Insert the franker cartridge

The franker cartridge is an ink stamp that marks the front of each check with an “Electronically Presented” message. Follow these directions to insert the franker cartridge into the unit.

Access the printer assembly

1. Press the cover latch and lift the cover to access the imaging frame.
2. Lift the imaging frame to access the feed plate.
3. Locate the black tab on the right side of the plate. Note the black tab in the same place on the left side of the plate. You will use the black tab to open the printer assembly.
 - a. Push the black tab to the left, away from the feed plate.
 - b. While holding the black tab, lift the feed plate up and to the right. It moves free of the black tab.
 - c. Push the blue tab to the right, away from the feed plate.
 - d. While holding the blue tab, lift the feed plate up and to the left. It moves free of the blue tab.
 - e. Remove the feed plate completely.

Insert the franker cartridge into the printer assembly

Under the feed plate, there is a hole in the plastic where you can insert the franker cartridge.

1. Insert the franker cartridge into the hole. The roller on the cartridge should face into the scanner.
2. Apply pressure to the widest part of the cartridge top until it clicks into place.
3. Replace the document feed plate by pressing down firmly until it clicks into place.
4. Close the imaging frame.
5. Close the outside cover.

Caution

- Avoid contact with the main drive roller to prevent ink transfer to documents.
- Ink may be harmful if swallowed.
- Avoid contact with eyes.
- Damage to the unit or the cartridge resulting from modifying the cartridge is not the responsibility of RDM.
- The cartridge is not refillable.
- The franker cartridge is not licensed for modifications.

Connect to a telephone line

If you have purchased a scanner with a modem, follow these directions to connect to a telephone line.

1. Insert the end of the telephone cord into the TEL port on the back of the scanner.
2. Insert the other end of the telephone cord into a telephone jack in the wall.

CAUTION: Plug the telephone cord into an analog phone jack only; the modem will not work if it is plugged into a PBX digital line.

Connect the power cord

1. Insert the round end of the power cord into the power port on the back of the scanner. Align the flat side of the power connector facing up.
2. Plug the power cord into an electrical power outlet.
3. When you connect to power, the LED lights up. Your unit is now powered on.

CAUTION: Disconnecting the power source while the scanner is processing a transaction may cause data files stored in the unit's memory to be lost.

NOTE: The power adapter includes a locking mechanism that securely connects the power cord to the scanner. To prevent cord damage, do not pull on the cord. Firmly slide back the locking mechanism on the connector before disconnecting the power cord from the unit.

Drivers and software

The drivers for your scanner are installed on your computer when you install the check scanning application. There are many applications that support EC7000i and EC7500i scanners; most are available from third-party vendors.

If you are not sure where to acquire your check scanning application, check with whoever provided your scanner.

Install the receipt printer paper roll

If your scanner includes a receipt printer, use single-ply, thermal-sensitive paper. These rolls are 2.25 inches (5.8 cm) wide and can be purchased from office supply stores.

CAUTION:

- Handle thermal paper with care; friction, humidity, light, etc, will damage it.
- The scanner will not load paper into the printer if the end of the roll is wrinkled, folded, or torn. Cut the end of the paper straight across before trying to load it into the scanner.

To install a roll of paper:

1. Ensure that the scanner is powered on.
2. Open the top of the paper roll cover at the back of the unit.
3. Hold the paper roll with the paper feeding from the bottom and guide the end of the paper into the slot that enters the scanner. The feed mechanism will pull the paper into the unit.
4. Place the roll into the paper roll holder.
5. Close the paper roll cover.

Status signals for EC7000i and EC7500i

The scanner's status is shown through a single, multi-state LED (light-emitting diode), which is the light on the top, front, right-hand side of the unit. Additionally, the scanner beeps to provide more information. The tables below describe typical status signals and their meanings.

EC7000i light signals and beeps

The following tables are for EC7000i scanners with serial number 24x and higher. Your scanner's serial number is listed on the bottom of the unit. For more information on finding your serial number, see [Model and serial number](#).

Scanners with serial number 23x and below might also have these signal patterns if they are updated to firmware 5.4.0 or higher. For more information on what firmware your scanner is running, contact your distributor (reseller).

If your scanner has a serial number of 23x or lower and does not follow these signal patterns, your scanner has an older set of signals. See [Appendix A](#) for a list of those patterns.

Startup

Signals	Meaning / What to do
Red-green-amber flashing cycle followed by a solid amber light and then a long solid red light.	The scanner is starting up and performing diagnostics. Wait for the scanner to finish.
Green solid	The scanner is configured but idle. The scanner is ready.

Document scanning and processing

Signals	Meaning / What to do
Green flashing	The scanner is waiting for the user to insert a document into the feeder.
Green-red flashing cycle	The scanner is processing the document. Wait for the scanner to finish.
Red flashing and short beep	An error occurred during processing. Check the computer or terminal's display for instructions or refer to your scanning application's documentation. If you need more help, contact your distributor (reseller).

EC7500i light signals and beeps

Start up

Signals	Meaning / What to do
Red-green flashing cycle Or, red-red-green-green flashing cycle	The scanner is being configured by the application.
Green solid	The scanner is configured but idle. You can start a task by using the check scanning application on your computer.
Red solid	An error occurred during startup. Check your computer's display for instructions or refer to your scanning application's documentation. If you need more help, contact your distributor (reseller).

Document scanning and processing

Signals	Meaning / What to do
Green flashing	The scanner is waiting for the user to insert a document into the feeder.
Green-red flashing cycle	The scanner is processing the document. Wait for the scanner to finish.
Red flashing and short beep	An error occurred during processing. Check your computer's display for instructions or refer to your local procedures. If you need more help, contact your distributor (reseller).

A Typical Document Processing / LED Cycle

1. The LED is green (solid): the unit is idle.
2. The LED is green (flashing): the scanner is waiting for a document to be inserted for scanning.
3. The LED is green/red (flashing): the scanning operation is in progress.
4. The LED is green (solid): the scanning operation is complete. The scanner has returned to its idle state.

Cleaning your scanner

RDM recommends that you periodically clean the scanner to remove dust, ink and debris build-up to ensure optimal performance and extended scanner life. Please follow the cleaning methods provided below.

There are two ways to clean your RDM scanner:

- Use the RDM ScannerCare application installed on your computer.
- Follow the instructions provided in *Manual cleaning* on page 19.

Cleaning the scanner with the RDM ScannerCare application

If you cannot find the ScannerCare program, you can clean your scanner manually. See *Manual cleaning* on page 19.

1. Run the ScannerCare program:
 - Search your computer for “ScannerCare”, and run the ScannerCare application.
2. Select the “ScannerCare” tab.
3. Select the “Clean scanner” sub-tab:

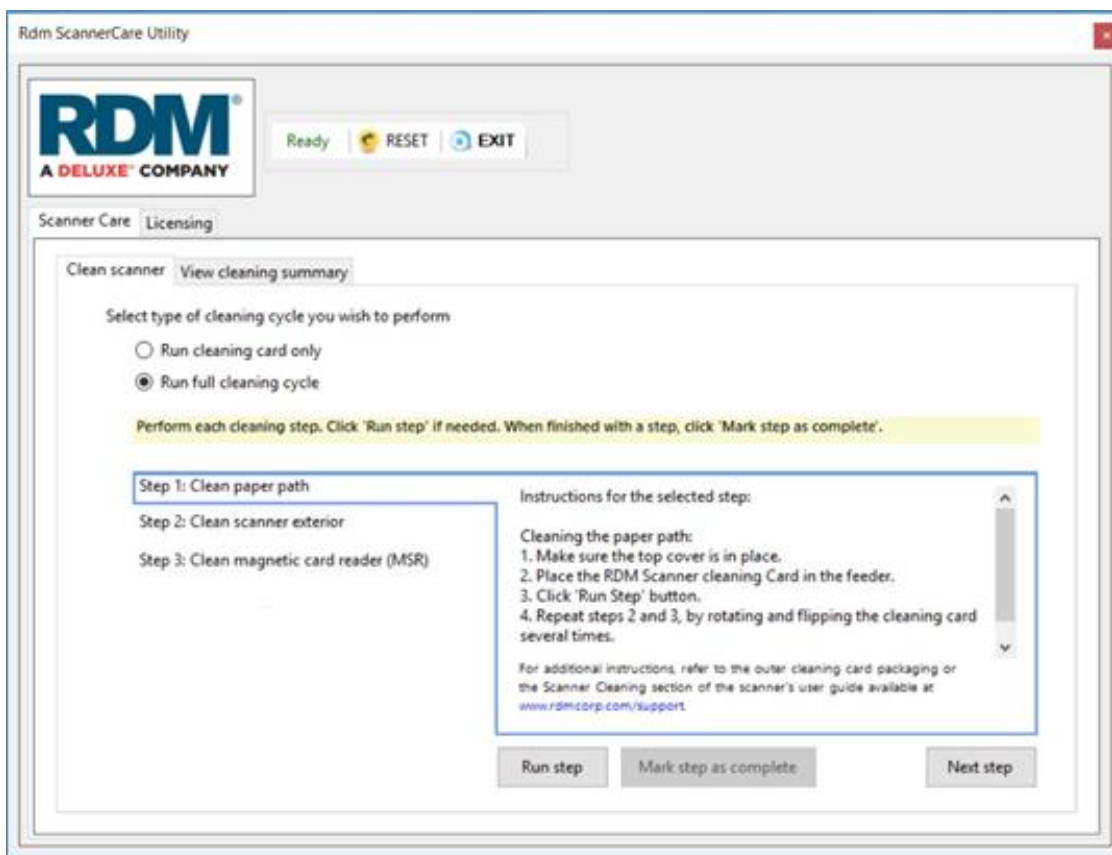

4. Choose to run either the cleaning card only, or run a full cleaning cycle.
5. Perform each step. Click on each step as needed, and follow the instructions.
 - a. Click the “Run step” button to begin the step.
 - b. When the step is completed, click the “Mark step as complete” button.
 - c. Click on either the next step, or the “Next Step” button to advance to the next step.
 - d. Continue until all steps are completed.
6. Select the “View cleaning summary” sub-tab:

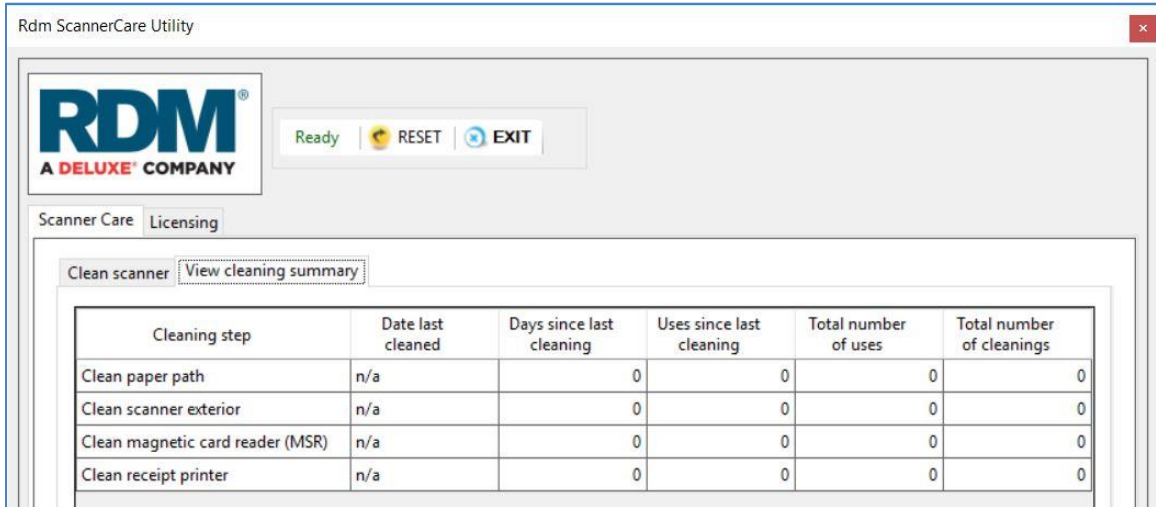

7. Review the cleaning summary for the scanner. The summary shows various information related to each scanner cleaning step.

Manual cleaning

Scanners perform best when all working surfaces are clean and free of foreign material.

Caution:

- Always disconnect the scanner from its power source before manual cleaning.
- Solvents or harsh cleaners might damage or discolor the cabinetry.

Cleaning the outside cabinetry

Use a damp cloth and mild soap.

Cleaning the inside of the scanner

To clean the inside of the unit:

1. Press the latch and lift the cover to access the imaging frame.
2. Lift the imaging frame to access the document feed plate.
3. Locate the blue tab on the right side of the plate. Note the black tab in the same place on the left side of the plate.
You will use the black tab to open the printer assembly.
 - a. Push the black tab to the left, away from the feed plate.
 - b. While holding the black tab, lift the feed plate up and to the right. It moves free of the black tab.
 - c. Push the blue tab to the right, away from the feed plate.
 - d. While holding the blue tab, lift the feed plate up and to the left. It moves free of the blue tab.
 - e. Remove the feed plate completely.
4. Ensure that the black fingers on the baffle move freely.

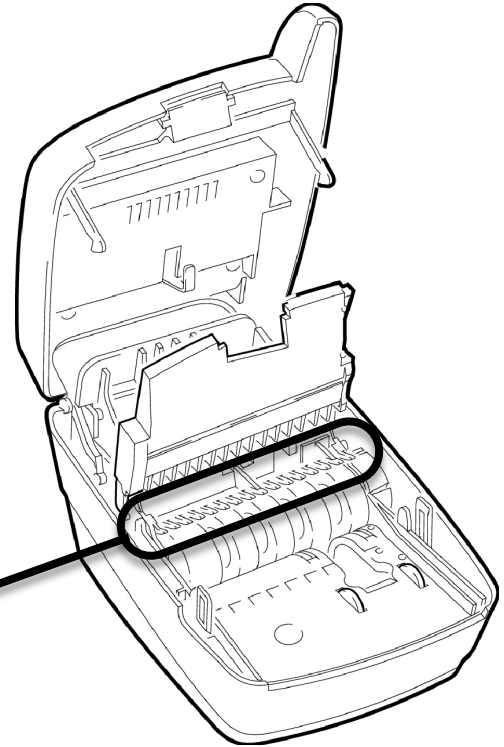
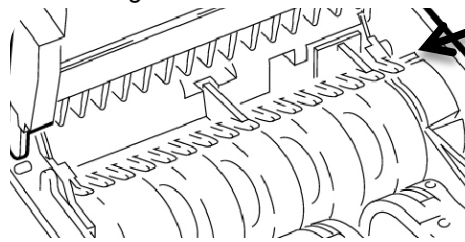

5. Use a dusting brush designed for use on electronic equipment or use compressed air to remove dust or debris.

Cleaning the imaging camera glass

If there are horizontal lines in the image of the scanned document, you should clean the imaging camera glass.

To locate and access the imaging camera glass:

1. Press the latch and lift the cover to access the imaging frame.
2. Lift the imaging frame to access the document sensors.
3. Use a lens-cleaning tissue or a damp, lint-free cloth to remove any ink or dust from the imaging camera glass.

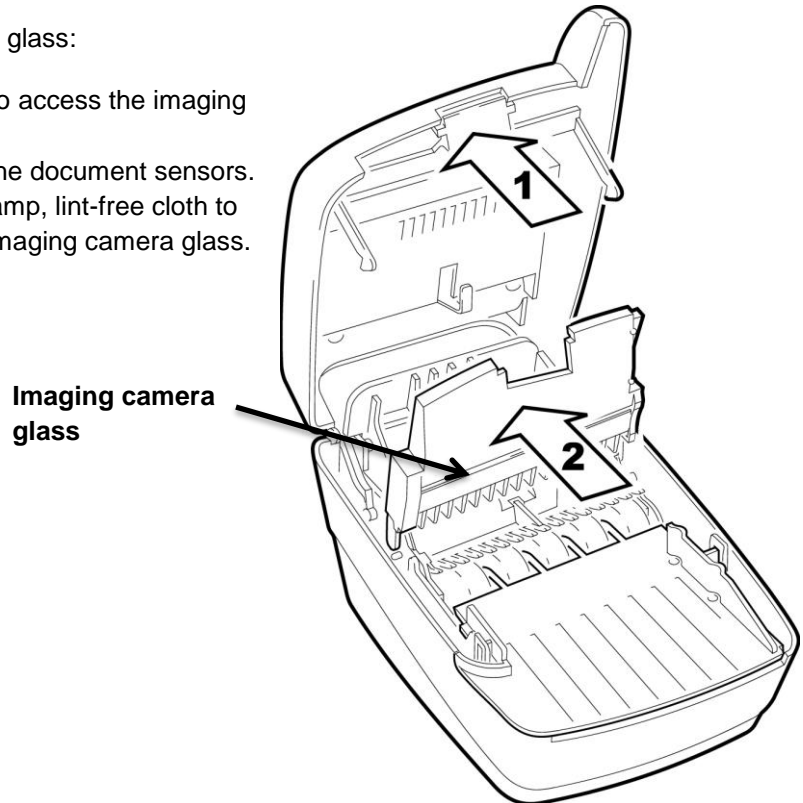

Troubleshooting

In the course of everyday operations, you may encounter minor malfunctions in your scanner. Before calling for service, review the troubleshooting steps below.

Scanner does not respond

Ensure that the scanner's cable is still properly connected to the correct port on the back of the unit (according to instructions provided by your distributor or reseller).

If the problem persists, contact your distributor or reseller.

Ensure that the correct power adaptor is connected to the unit. Change or replace the adapter, if necessary.

Scanner modem cannot connect to the telephone line

If your scanner is not connecting to the telephone line:

1. Check that the telephone cord is plugged into both the scanner and the telephone jack.
2. Check that the telephone cord you are using is not damaged. Connect the telephone cord to a telephone. If the line operates normally, the cord does not need to be replaced.
3. Call the phone number of the telephone line to ensure that it is working properly.
 - If you cannot connect to the telephone line, contact your telephone company to repair the line.
 - If you can connect to the telephone line, contact your distributor to have the scanner serviced.

The check feeder does not function properly

Ensure that you are inserting the check properly: flush to the right side of the scanner, information-side facing up, with the MICR line to the right. If the problem persists, contact your distributor. Remove any debris by following the directions below:

1. Press the latch and lift the cover to access the imaging frame.
2. Lift the imaging frame to access the document feed plate.
3. Clear any paper or debris from the imaging frame and document feed plate.
4. Ensure that the black fingers on the baffle move freely.

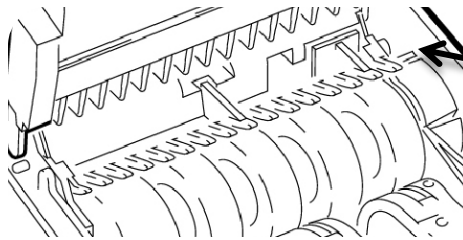

5. Use a lens-cleaning tissue or a damp, lint-free cloth to remove any ink or dust from the document sensors.
6. Ensure that the rollers under the baffle are clean.
7. Close the imaging frame and cover.

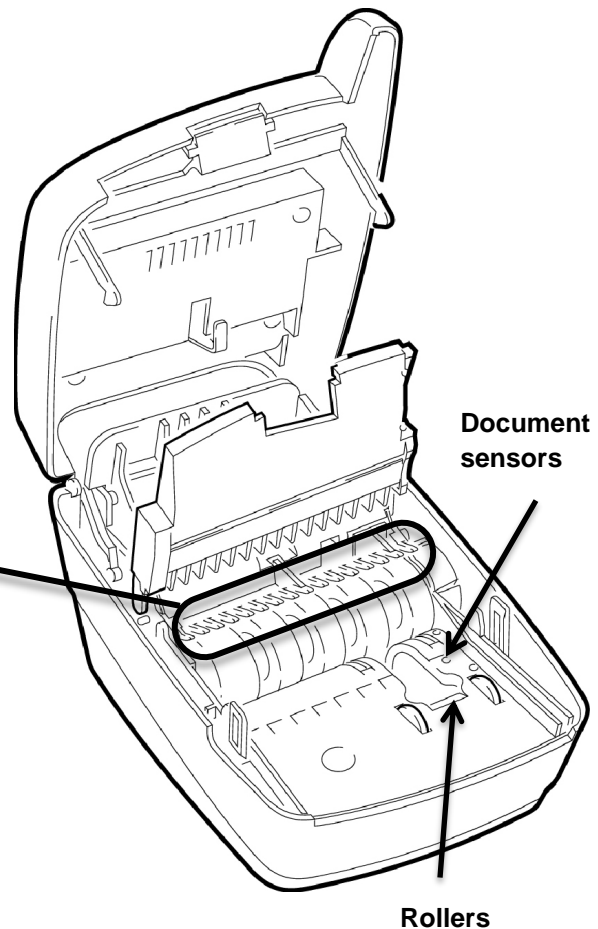

Card transactions do not function properly

Test the Card Swipe Mechanism

1. Ensure that you are swiping the card properly. The black magnetic stripe on the back of the card must face downward and to the left.
2. Try using another card to ensure the first card was not defective.

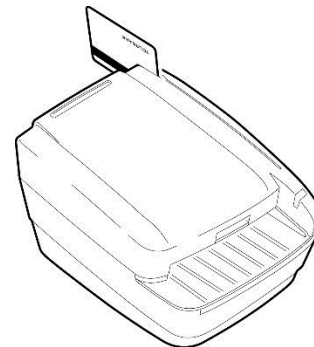

Specifications

EC7000i and EC7500i Specifications	
Unit size	Without MSR 8.6" long x 6.1" wide x 4.4" high 21.9 cm long X 15.4 cm wide X 11.3 cm high With MSR 8.6" long x 6.1" wide x 5.3" high 21.9 cm long x 15.4 cm wide x 13.5 cm high With Printer 11.8" long x 6.1" wide x 5.3" high 30.1 cm long x 15.4 cm wide x 13.5 cm high
Unit weight	EC7000i: 3.4 lbs. / 1.5 Kg EC7504f with printer: 6.0 lbs / 2.7 Kg with power supply
Unit orientation	For proper operation, place unit on a level, horizontal surface.
EC7000i connectors	Power: Red. Mini-DIN 3-pin. USB: Orange. USB-A. (1.1) AUX: Yellow. Mini-DIN 8-pin. COM: Green. Mini-DIN 9-pin. TEL: Purple. RJ11 plug. Modem (optional).
EC7500i connectors	Power: Mini-DIN 3-pin USB: USB-B (2.0)
Environmental	
Operating temperature	32 to 104 degrees F (0 to 40 degrees C).
Operating humidity	10 to 85% relative humidity (non-condensing).
Document Specifications	
Document size and weight	Nominal: 2.16" W x 4.4" L (5.5 cm x 11.2 cm) Maximum: 4" W x 9" L (10.16 cm x 22.86 cm) Preferred Paper Weight Range: 20 lb to 32 lb
MICR fonts	E13B MICR Character Set CMC7 MICR Character Set
OCR font recognition (optional license)	Under application control Alphanumeric OCR A and B font recognition of OCR code-lines for applications such as bill payment
Electrical Power Requirements for Power Adapter	
Power supply	Input: 100–240 V AC, 50–60Hz Output: 24V, DC 1.0A For use with model no GFP241DA-2410M-2 or 3A-242DA24. Pour utiliser avec modèle GFP241DA-2410M-2 or 3A-242DA24.

Software and support	
Supported operating systems	Windows XP, Windows 7 (32/64-bit), Windows 8 (32/64-bit), Windows 8.1 (32/64-bit)
Development software	RDM EC Scanner Application Development Kit (ADK) includes API components, USB driver, Redistributable Installation Packages and Sample Applications

Modem Specifications (Optional)	
Supports	V.34bis, V.34 V.F.C, V.32bis, V.32, V.22bis, V.22A/B, V.23, V.21, Bell 212A and 103
Error correction	V.42 LAPM and MNP 2-4
	V.42bis and MNP 5
Magnetic Stripe Reader (MSR) Specifications (Optional)	
	3 track, bi-directional

Accessories and consumables

Options and accessories	RDM Part Number
Replacement franker cartridge – “Electronically Presented” - red ink	6000-6050
Replacement franker cartridge (EC6XXX/7XXX/SYNERGY) – “Electronically Presented” red ink (FRENCH)	6000-6053
Replacement thermal paper roll, 2.25” x 50’ (58 mm x 15 m)	Standard thermal roll paper available from office supply stores
Replacement power adapter (EC7000i, EC7500i)	302843
Optional Aux to PC serial cable, mini-DIN9 to DB9 – (EC7000i models)	5000-40012
USB Cable, Type A to A (EC7000i models)	5000-40091
USB 2.0 cable, A to B male, shielded (EC7500i models)	6000-6106
Modem cable, RJ11 to RJ11 (EC7014f)	5000-40063

Appendix A

This appendix describes the EC7000i series scanners' LED and beep signal patterns for serial numbers 23x and lower.

Startup

Signals	Meaning / What to do
Red/Green/Amber flashing cycle	The scanner is starting up and performing diagnostics. Wait for the scanner to finish.
Solid red	The scanner failed a start-up test. Check the computer's display for instructions. If you need more help, contact your distributor (reseller).
Solid amber	The scanner is ready. You can start a task by using the check application on your computer or terminal.

Document scanning and processing

Signals	Meaning / What to do
Green solid	The scanner is ready to scan a document. Insert a document.
Green flashing	The scanner is processing the document. Wait for the scanner to finish.
Green flashing and one short beep	The scanner read the MICR line successfully.
Amber flashing	The scanner is communicating with your computer or terminal. Wait for the scanner to finish.
Red flashing and three short beeps.	The scanner failed to read the MICR line. Check the computer or terminal's display for instructions or refer to your local procedures. If you need additional assistance, contact your distributor (reseller).
Red flashing and one long beep	An error occurred processing or storing the document image. Check the computer or terminal's display for instructions or refer to your local procedures. If you need additional assistance, contact your distributor (reseller).

Warranty Information

LIMITED WARRANTY:

The RDM EC7000i and EC7500i units are warranted against defects in materials and workmanship under normal use and service for a period of two years. This warranty is extended only to the original purchaser.

The entire liability of RDM Corporation (the Corporation), distributors of the EC7000i and EC7500i and manufacturers of auxiliary equipment used with the EC7000i and EC7500i and your exclusive remedy shall be, at the Corporation's option either (a) return of the price paid, or (b) repair or replacement of the EC7000i and EC7500i that does not meet this limited warranty and which is returned to the Corporation with a purchase receipt or other proof of date of original purchase which will be required in order to exercise your rights under this warranty.

The limited warranty is void if failure of the EC7000i or EC7500i has resulted from accident, abuse or misapplication. Any replacement of the EC7000i or EC7500i will be warranted for the remainder of the original warranty period.

The equipment is sold with the understanding that neither the Corporation, such distributors nor such manufacturers will be liable for any damages whatsoever (including, without limitation, direct or indirect damages for personal injury, loss of business profits, business interruption, loss of business information, or any other pecuniary loss) arising out of the use of or inability to use the EC7000i or EC7500i, even if the Corporation, such distributors and/or such manufacturers have been advised of the possibility of such damages.

In any case, the entire liability of the Corporation, such distributors and such manufacturers with respect to the EC7000i or the EC7500i shall be limited to the amount actually paid by you for the EC7000i or the EC7500i.

The Corporation, such distributors and such manufacturers disclaim all other warranties, express or implied, including, without limitation, implied warranties of merchantability and fitness for a particular purpose with regard to the EC7000i or the EC7500i and the accompanying written materials.

Although every effort has been made to ensure the accuracy of the information contained in this guide, no warranty or representation to that effect is made. Due to product improvements, specifications are subject to change without notice.

WARRANTY SPECIFICS:

This warranty only covers failures due to defects in materials or workmanship, which occur during normal use. It does not cover the following:

Damage, which occurs in shipment,

Failures which are caused by products not supplied by RDM or failures which result from accident, misuse, abuse, neglect, excessive dirt or dust caused by lack of preventive maintenance measures, mishandling, misapplication, alteration or modification; service by anyone other than RDM, or damage that is attributable to acts of nature including but not limited to:

Flood, lightning, power surges or static electricity, water damage, falls, theft, or vandalism,

Spillage of liquid or objects that have fallen into the equipment,

Equipment that has been exposed to excessive heat or unstable environmental conditions,

Consumables such as Franker cartridge or Franker Assembly, or other EC7000i or EC7500i consumables or accessories such as roll paper or cables.

RDM's EC7000i or EC7500i units with problems found to be caused by incorrectly set configuration parameters (IRN #, Owner Code, Merchant ID, etc.) are not considered defective and will not be serviced under warranty.

Warranty is void if any of the external case of the unit has been opened or removed or the unit has, in RDM's opinion, been damaged through misuse or improper care.

Units returned to RDM for warranty repair will be re-configured with factory defaults and returned to customers. All stored images in the scanner will be cleared.



RDM EC9100i Series Scanners

User Guide



January 2021

Copyright

Copyright ©2021 by RDM Corporation, a Deluxe Company (RDM).

All rights reserved. No part of this publication may be reproduced, stored in a retrieval system, or transmitted, in any form or by any means, electronic, mechanical, photocopy, recording, or otherwise, without the prior written permission of RDM Corporation.

Trademarks

RDM, ITMS, Simply Deposit, Simply Deposit Mobile, Dynamic Decisioning Portal, DepositWatch+, QCX, QCV, EC6000i, EC7000i, EC7500i, EC9000i, EC9100i, EC9600i and EC9700i are trademarks or registered trademarks of RDM. All other brands and their products are trademarks or registered trademarks of their respective holders and should be noted as such.

Disclaimer

RDM makes no warranty with respect to the adequacy of this documentation, programs, or hardware that it describes for any particular purpose or with respect to the adequacy to produce a particular result. In no event shall RDM be held liable for special, direct, indirect, or consequential damages, losses, cost, charges, claims, demands, or claim for lost profits, fees, or expenses of any nature or kind.

RDM, By Deluxe

www.rdmcorp.com

End-User/Customer Agreement

Please read the end-user/customer agreement regarding software license and warranty terms during the installation of the application.

Compliance statements

FCC Compliance Statement

This equipment has been tested and found to comply with the limits for a Class A digital device, pursuant to Part 15 of the FCC rules. These limits are designed to provide reasonable protection against harmful interference when the equipment is operated in a commercial environment. This equipment generates, uses, and can radiate radio frequency energy and, if not installed and used in accordance with the instruction manual, may cause harmful interference to radio communications. Operation of this equipment in a residential area is likely to cause harmful interference in which case the user will be required to correct the interference at his own expense.

Warning: Changes or modifications not expressly approved by RDM could void the user's authority to operate the equipment.

All units covered by this manual have no user-serviceable parts inside. In the event repairs are ever needed to any RDM product, they should be performed by RDM Corporation or an authorized representative of RDM Corporation. For information please contact RDM Corporation,

619A Kumpf Drive, Waterloo, Ontario, Canada N2V 1K8, at 1-800-567-6227, or RDM's US service agent below.

US Service Agent
Kortney Nordrum
(651)-490-8614
compliance@deluxe.com

Contents

Copyright	2
Compliance statements.....	3
Contents	4
About this guide.....	6
Introduction.....	7
Your Scanner	8
Scanner Models.....	8
Status LED Signals	9
EC9100i series scanner	10
Single-feed (SF) models	10
Auto-feed (AF) models	11
Auto-feed (AF) printer models.....	12
Internal components	13
Inside the front cover - side view – Auto-Feed	13
Inside the front cover - side view – Single-Feed	13
Inside the front cover - back view	14
Inside the front cover and endorsement printer cover - top view.....	15
Connection ports	16
Setting up your scanner	17
Connecting the power cord.....	18
Disconnecting the power cord.....	18
Installing cartridges and paper roll.....	18
Drivers and applications.....	19
Operating the scanner	20
Preparing documents.....	20
Feeding documents	20
Single-feed (SF) models.....	20
Auto-feed (AF) models	21

Swiping magnetic stripe cards (optional).....	21
Imaging identification cards	21
Understanding light signals.....	22
Maintaining your scanner.....	23
Removing the covers	23
Front cover	23
Endorsement printer cover	23
Franker and endorser inkjet cartridges	24
Installing the franker cartridge.....	25
Installing the endorser inkjet cartridge	26
Replacing the inkjet blotter	27
Replacing the paper roll for the printer.....	27
Cleaning your scanner.....	28
Using RDM ScannerCare Cleaning Kit.....	28
Manual cleaning	29
Troubleshooting.....	31
Scanner does not respond.....	31
Card transactions do not function properly	31
Printer does not print	31
Specifications.....	32
Warranty Information	35
LIMITED WARRANTY:.....	35
WARRANTY SPECIFICS:	36

About this guide

This guide describes the EC9100i series scanners, some basic operations, and how to maintain your scanner. For instructions on how to use your scanner to scan documents with your computer, contact your solution provider.

Requirements

The scanner is for indoor use only. Keep the scanner dry; avoid areas of high humidity.

Do not remove any parts from areas that are not described in this guide. Removing parts from areas not described in this guide will void the warranty.

When you are working inside the scanner, such as when you are replacing the franker cartridge, make sure the scanner's power is disconnected.

Recommendations

Record all distributor contact information for future reference.

Save the original box and packing material. Reuse them if the unit must be shipped to a new location or returned for service.

Position the unit so that the operator has easy access to the document path and a clear view of the LED. Do not put the unit close to a heat source, in direct sunlight, or close to any device that can emit electromagnetic interference, such as a computer monitor or power adapter.

Introduction

The RDM EC9100i series scanners provide affordable functionality in a compact, efficient design. Featuring RDM's industry leading Progressive MICR Method and imaging technology, the EC9100i series scanners deliver optimum MICR read rates and image quality.

With several models and feature options to choose from, the RDM EC9100i series scanners are an ideal fit for payment applications such as remote deposit capture, check cashing, teller capture, healthcare POS, retail POS, and walk-in bill payments. Scanners are available in single-feed and auto-feed models, with speeds up to 90 documents per minute on some models. All models include an integrated ID card imager.

To accommodate applications such as walk-in bill payments, the EC9100i series can be licensed for OCR A and B font recognition capability. You can tell if your scanner is licensed for OCR by the label on the bottom or back of the scanner.

Your Scanner

Scanner Models

The following table lists the available EC9100i models and their key features.

	Single-Feed	Multi-Feed	MSR	3 Thermal Receipt Printer	Franker Enabled	Ink-jet Endorser Enabled	Document feeder capacity	Document throughput (DPM)
EC9111f	•				•		1	
EC9112f	•		•		•		1	
EC9103f		•			•	•	30	30/90
EC9104f		•	•		•	•	30	30/90
EC9108f		•	•	•	•	•	30	30/90

There is a label on your scanner that includes the following details about your scanner:

- The scanner’s model number
- The scanner’s serial number
- The speed of your scanner (30 documents per minute in the example below)
- Whether the scanner is licensed for OCR (the example below is not licensed for OCR scanning)

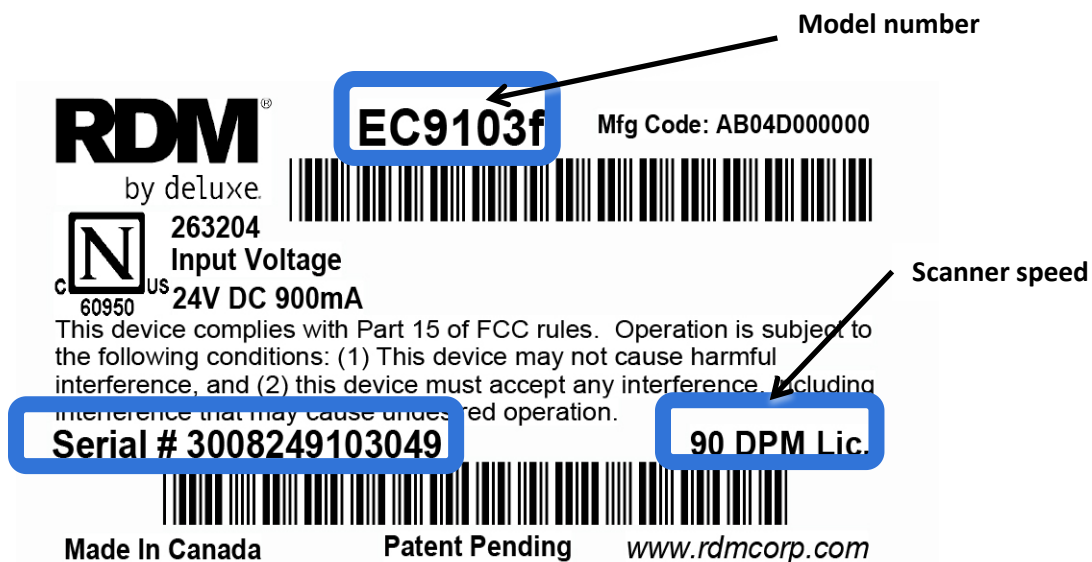

You can locate your scanner’s label on the bottom or back of your scanner.

Status LED Signals

This status L.E.D. (Light Emitting Diode) is located on the front right of the scanner. The light indicates the status of the scanner. For more information, see *Light signals and beeps on page 22*.



EC9100i series scanner

Single-feed (SF) models



Auto-feed (AF) models

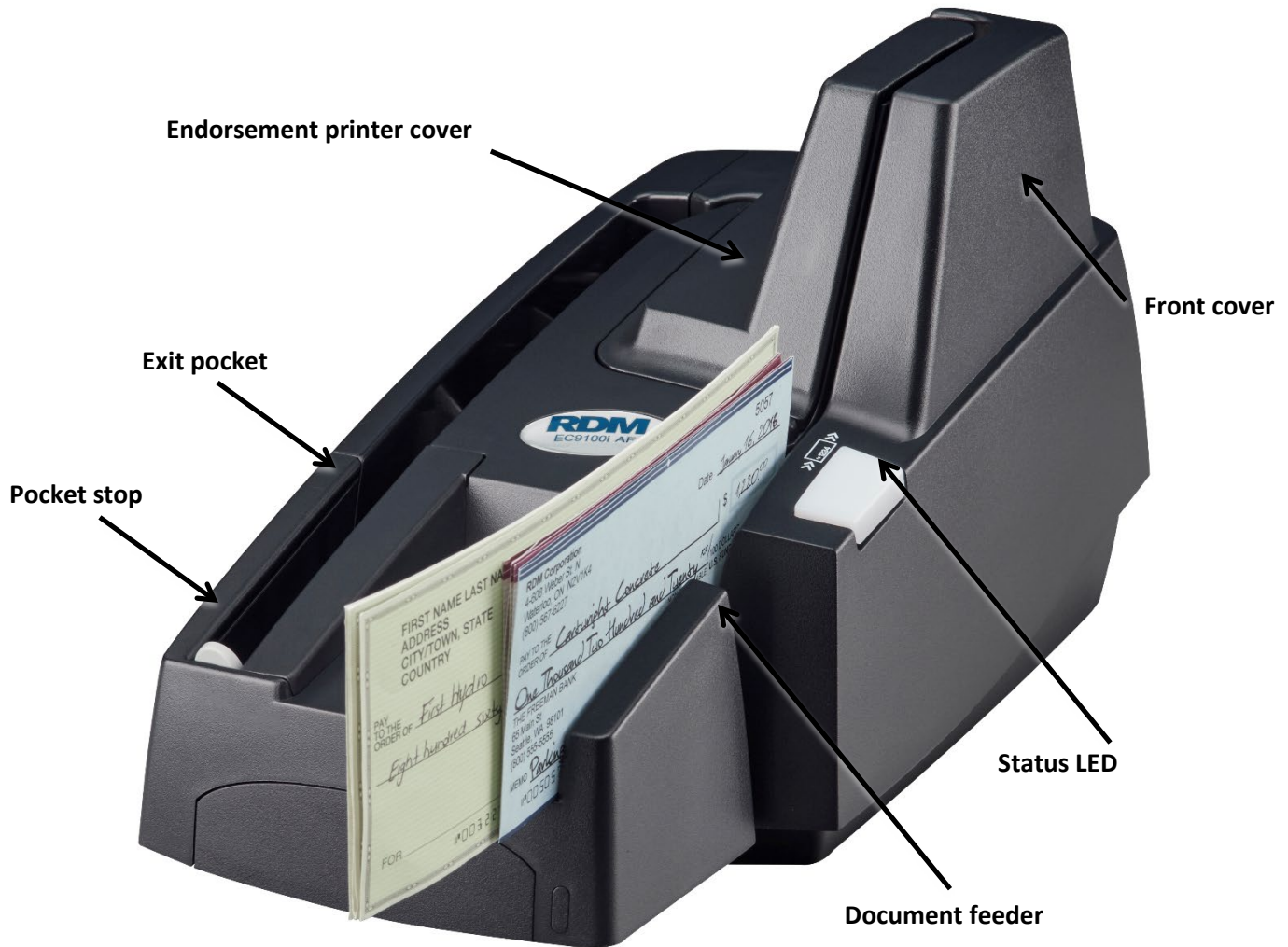

Auto-feed (AF) printer models



Internal components

Inside the front cover - side view – Auto-Feed

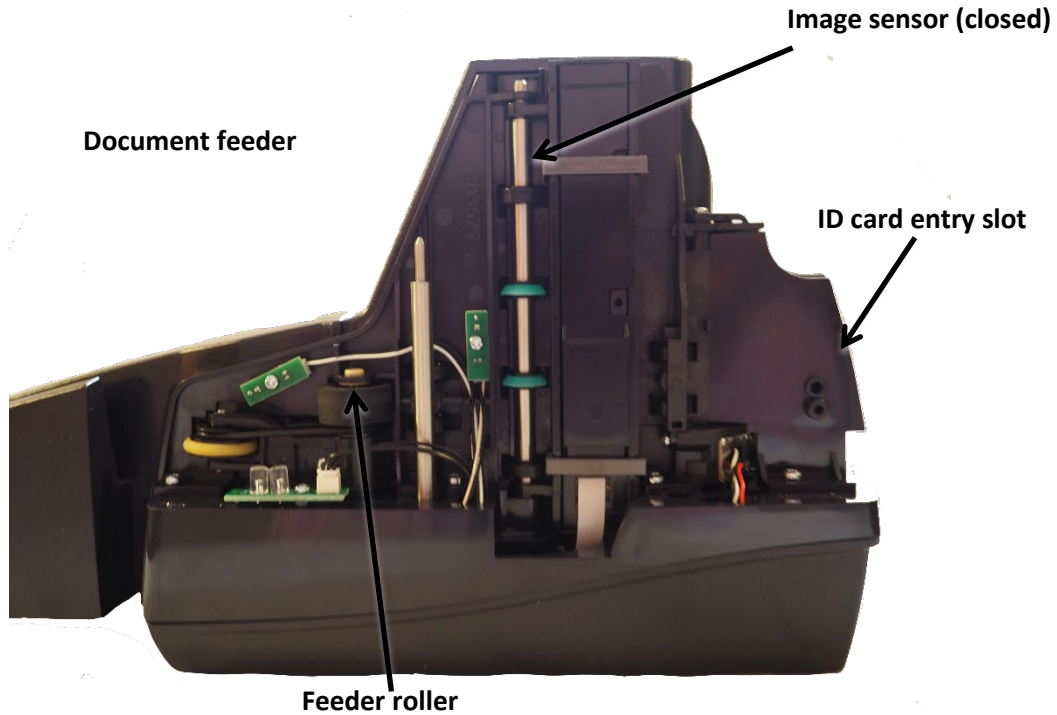

Inside the front cover - side view – Single-Feed

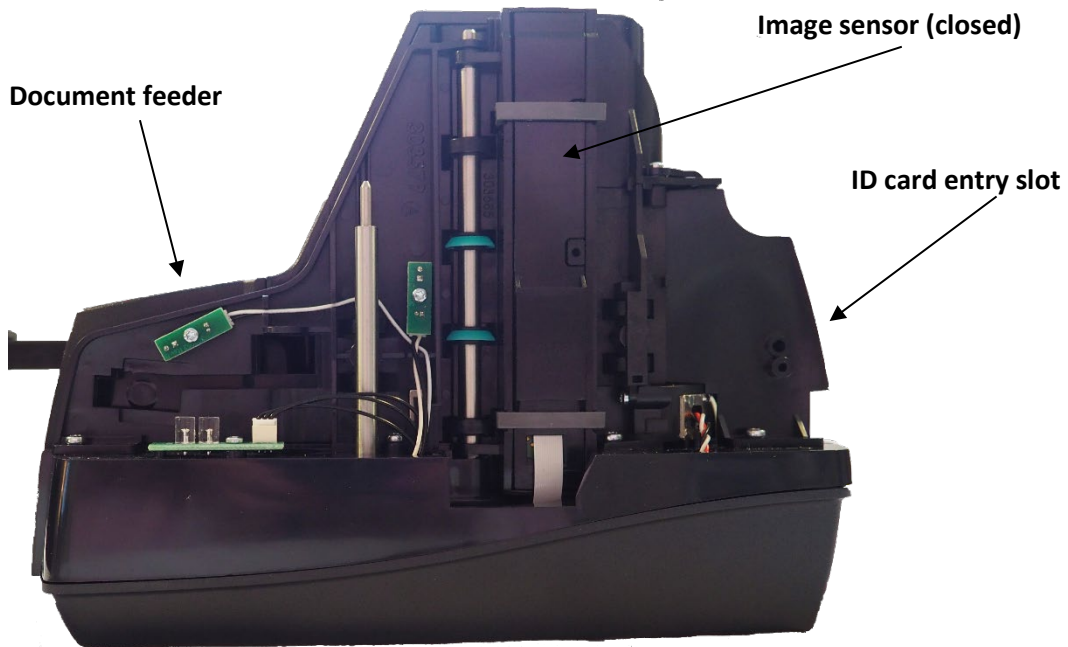

Inside the front cover - back view

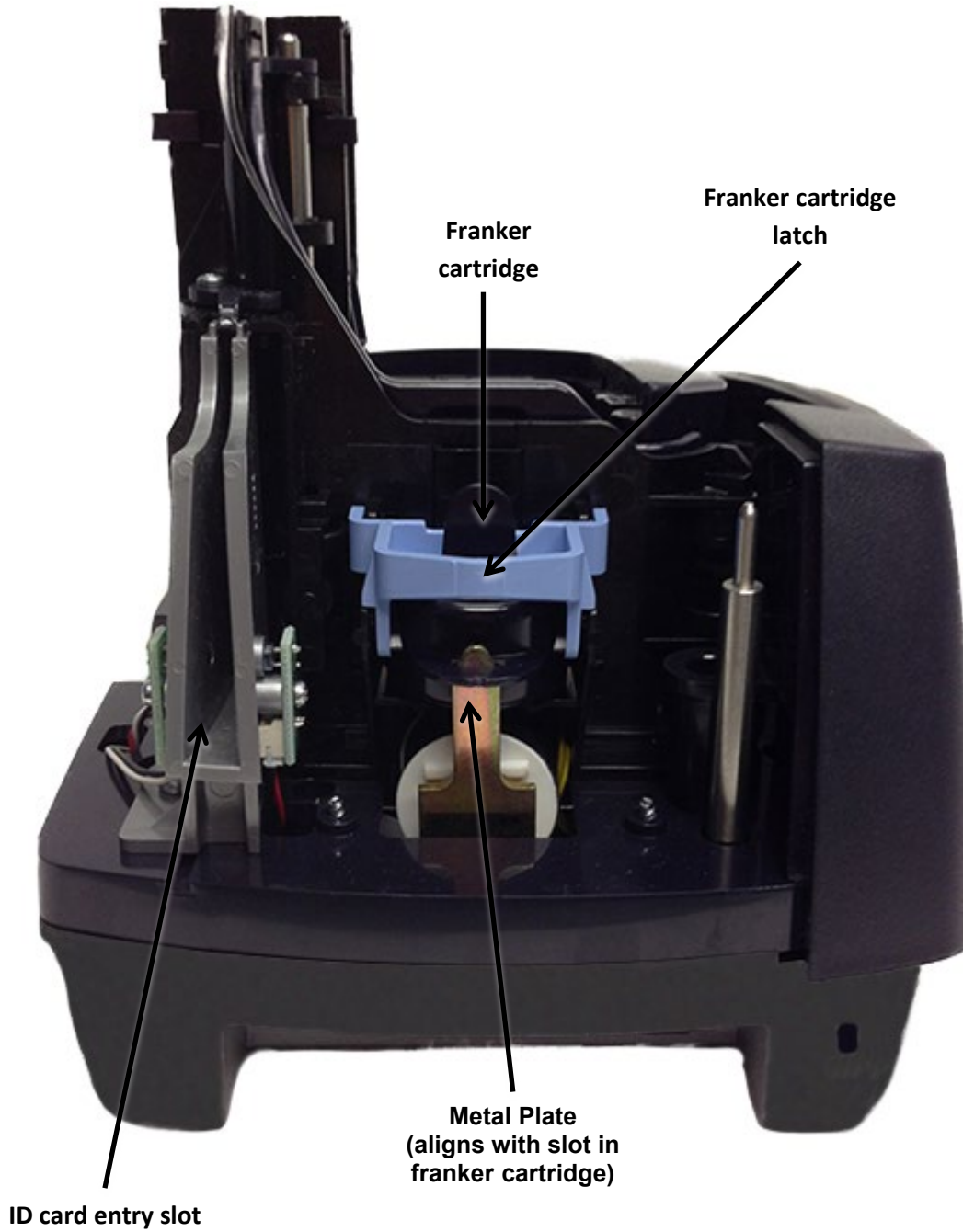

Inside the front cover and endorsement printer cover - top view

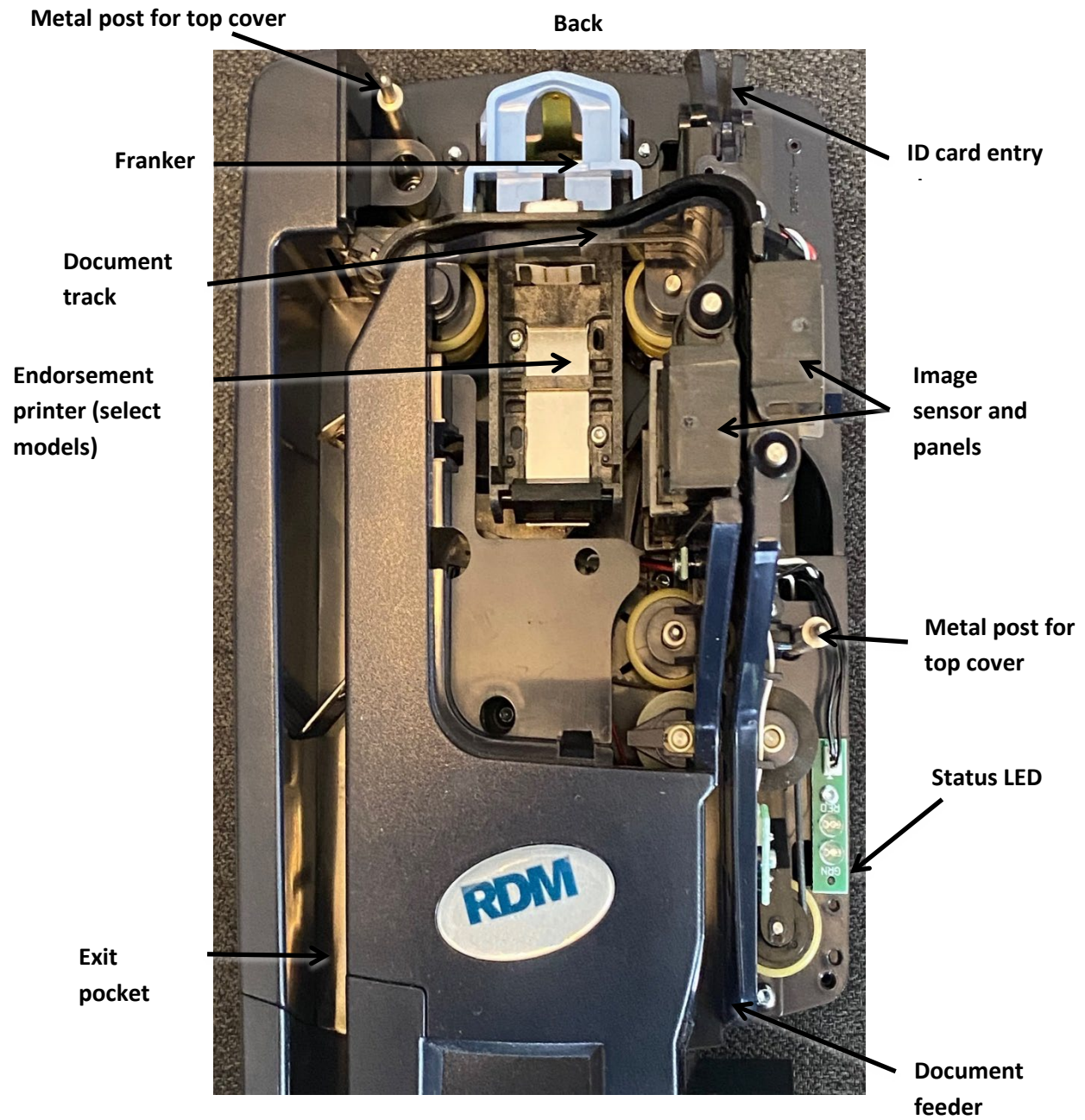

Connection ports



USB

Power

*** Note:** Not all scanner models include every item shown in the diagrams. Some earlier models will also have a USB hub.

Connector/Port	Description
USB Port	High-speed 2.0 (480 mbps). Use this port to connect to a computer. You must use the USB A to B cable.
Power	Connect the power adapter to this port.
K-Slot	The K-Slot or Kensington® Security Lock lets you secure the unit with a cable (not provided) that locks into the slot. Cables can be purchased from your local computer supply store.

Setting up your scanner

To set up your scanner:

- Choose a location.
- Unpack the shipping box.
- Inspect the scanner's features.
- Insert the franker cartridge (sold separately).
- Insert the inkjet endorsement printer cartridge (sold separately).
- Insert the receipt paper roll, if one is included with your scanner.

Choosing a location

Locate your scanner in a place that:

- Has a flat surface, such as a counter top or table.
- Is convenient for the scanner operator.
- Offers adequate ventilation and protection from elements such as heat, dust, oil, or moisture.
- Is close to the application computer.
- Is close to an electrical outlet.

Unpacking the shipping box

1. Open the top of the box.
2. Remove and unwrap the items. Lift the scanner out of the box from the bottom of the scanner.
3. Save the box and packing material for future use.

The shipping box includes the following items:

- Scanner
- USB cable (A to B)
- Power adapter
- 5-pack inkjet blotter (models with inkjet endorsement printer)
- 3" thermal receipt paper roll (models with receipt printer)

Connecting the power cord

1. Align the flat side of the power connector so that it is facing up.
2. Insert the round end of the power cord into the power port on the back of the scanner until it clicks into place.

Note: Although the status light on the scanner might illuminate without the power cord being fully connected to the scanner, **you must push the power cord until it clicks into place for the scanner to function correctly.**

3. With the power cord connected to the power adapter, plug the other end of cord into an electrical outlet.
4. If your power cord has an on/off switch, make sure the switch is in the “on” position.

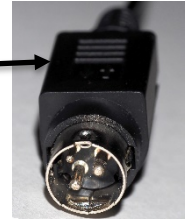

Click here to view video: [How to connect your RDM EC9100i series check scanner](#)

Alternatively visit: <https://www.youtube.com/user/RDMCorporation/playlists>

Disconnecting the power cord

Caution: Disconnecting the scanner from a power source while the scanner is processing a transaction might cause data loss.

The power cord has a sleeve on it that secures it to the unit. The security sleeve prevents the power cord from being pulled out of the unit accidentally.

1. Hold the unit in place with one hand to prevent the unit from falling.
2. With your other hand, slide the power cord security sleeve back and pull the power cord free of the scanner.

Installing cartridges and paper roll

For installing the franker cartridge, see *Replacing the franker cartridge on page 25*.

For installing the endorser inkjet cartridge, see *Replacing the endorser inkjet cartridge on page 26*.

For installing the paper roll, see *Replacing the paper roll for the printer on page 27*.

Drivers and applications

There are many applications that support the RDM EC9100i. Most are available from third-party vendors. If you are not sure where to acquire your payment application, check with whoever provided your scanner.

The drivers for RDM EC9100i series scanners are installed on your computer when you install your payment application.

Operating the scanner

Caution: Do not open the cover or try to access the inside of the scanner while it scans a document.

Preparing documents

To reduce the possibility of errors and damage to the unit:

- Remove all folds and creases in the document.
- Remove any paper clips and staples from the document.
- Make sure that documents are not stuck together.
- Make sure that documents are dry.

Feeding documents

The scanner unit is ready to accept documents when the LED is flashing green. Insert the documents either one at a time with single-feed (SF) models, or in a batch with auto-feed (AF) models.

Make sure that you place the documents into the feeder with the MICR line at the bottom and facing towards the outside of the scanner.

Caution: Adjust the exit extension or the pocket stop to fit the documents that you are scanning. Documents can be damaged or jam in the scanner if the exit extension or pocket stop is not fitted to the documents.

Single-feed (SF) models

1. Start the scanning process. For example, click Scan on your scanning application.
2. Hand-feed a document into the feeder until the scanner pulls the document through the transport.

The document is scanned and processed.

3. Repeat steps 1 and 2 until you have scanned all your documents.



Click here to view video: [Feeding checks on a RDM single-feed check scanner](#)

Alternatively visit: <https://www.youtube.com/user/RDMCorporation/playlists>

Auto-feed (AF) models

1. Place up to 30 documents into the document feeder.
Note: Do not push documents past the check icon on the right side of the document feeder.
2. If you are required to do so, start the scanning process. For example, click Scan on your scanning application.

Click here to view video: [View Feeding checks on a RDM Auto-feed check scanner](#)

Alternatively visit: <https://www.youtube.com/user/RDMCorporation/playlists>

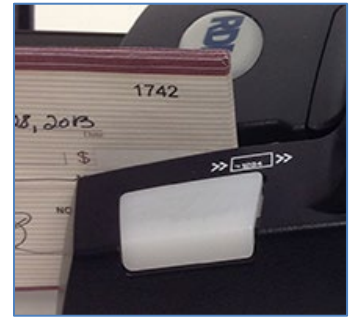

Swiping magnetic stripe cards (optional)

1. Place the card in the slot on the side of the scanner with the stripe down and facing towards the body of the scanner.
2. Swipe the card from front to back.



Imaging identification cards

The ID imager uses the same track as the document scanner, but you insert ID cards at the back of the scanner. Insert the card into the scanner so that the front of the ID card faces away from the scanner. The ID imager scans both the front and back of the identification card.

1. Insert the identification card into the back of the scanner track until you feel the scanner pinch the card. The scanner pulls the card through the track.
2. Remove the card from the front of the scanner track.



Understanding light signals

The scanner's status is shown through a single, multistate LED (light-emitting diode), which is the light on the top, front, right-hand side of the unit. The tables below describe typical status signals and their meanings.

Status	Signals	Meaning
<i>After starting the scanner:</i>	Red and green flashing cycle	The scanner is being configured by the scanning application.
Idle	Green solid	The scanner is ready and idle.
<i>Scanning</i>	Green flashing	The scanner is waiting for the user to insert a document into the feeder.
<i>Scanning</i>	Green and red flashing cycle	The scanner is processing the documents. Wait for the scanner to finish.
<i>Error</i>	Red flashing	An error occurred while the scanner was processing the document. Check your PC application for instructions or refer to your local procedures. If you need more help, contact your distributor (reseller).

Signals in a typical document processing cycle

1. The LED is Green (Solid): The unit is idle.
2. The LED is Green (Flashing): The scanner is waiting for a document to be inserted for scanning.
3. The LED is Green/Red (Flashing): The scanning operation is in progress.
4. The LED is Green (Solid): The scanning operation is complete. The scanner has returned to its idle state.

Maintaining your scanner

Removing the covers

RDM EC9100i scanners have two covers that can be removed in order to clean the image sensor, replace cartridges, or clear paper jams.

Front cover

Remove the front cover when you need to clear paper jams, replace the franker cartridge, or clean the image sensor.

1. Disconnect the power cord from the scanner.
2. Pull the insertion extensions forward.
3. Grasp the front and the back end of the front cover.
4. Gently pull the cover upwards until it detaches from the scanner.

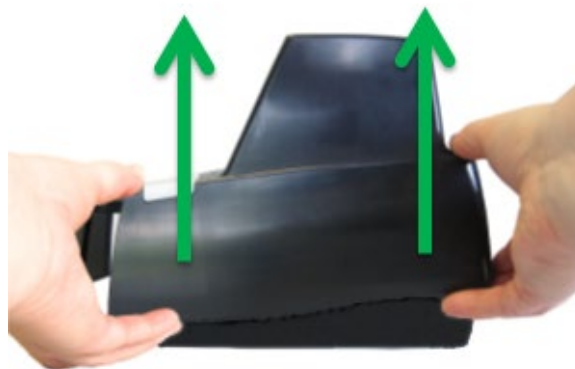

To replace the front cover:

Caution: Before you replace the front cover, make sure the insertion extensions are pulled forward. Otherwise, you might damage the front cover.

1. Carefully place the front cover over the scanner assembly. Make sure that the cover overlaps the assembly correctly by lining it up with the metal posts.
2. Gently push the cover down until it snaps into place.

Endorsement printer cover

Remove the endorsement printer cover when you need to clear paper jams, to insert or replace the endorser inkjet printer cartridge, or to clean the image sensor.

1. Grasp the top of the endorsement printer cover.
2. Gently pull the cover upwards until it detaches from the scanner.

To replace the endorsement printer cover:

1. Carefully place the endorsement printer cover over the scanner assembly; make sure that the cover overlaps the assembly correctly.
2. Gently push the cover down until it snaps into place.

Franker and endorser inkjet cartridges



Franker cartridge
Item# 6000-6065

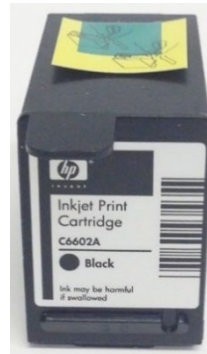

HP C6602A Black
Endorser inkjet cartridge
Item# 6000-6060

The franker cartridge creates a red ink stamp that defaces the front of each check with a message that says, "Electronically Presented". Franker cartridge must be purchased separately.

Certain EC9100i scanners are capable of endorsing checks, but the cartridges are not included with scanners. With your scanning application, the endorser inkjet printer places user-defined text on the rear of the check.

Franker or inkjet cartridges can be purchased by contacting your solution provider or reseller.

Follow the directions below to insert the cartridges into the scanner unit.

Caution:

- Ink might be harmful if swallowed.
- Avoid contact with eyes.
- Damage to the unit or the cartridge which results from modifying the inkjet cartridge is not the responsibility of RDM.
- The inkjet cartridge is not refillable.
- Inkjet cartridges are not licensed for modifications.
- RDM may change product designs, features, or specifications at any time.

Installing the franker cartridge

1. Remove the front cover of the scanner.

At the back of the scanner, the franker cartridge is held in place by a blue franker latch and a metal plate.

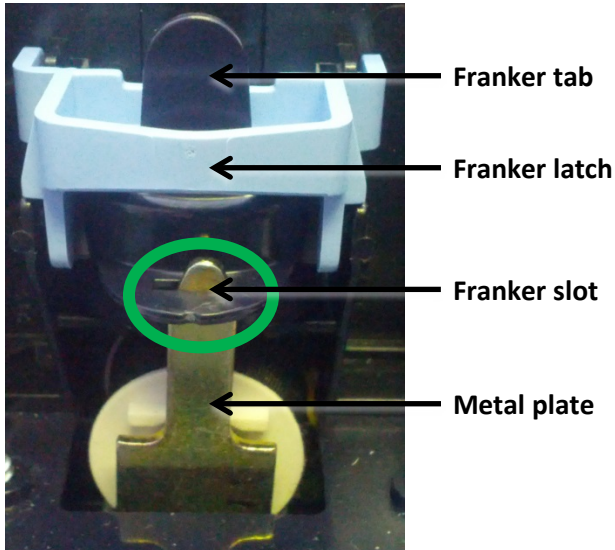

2. Lift the blue franker latch.
3. Pull the franker cartridge out of the scanner by the franker tab.
4. Insert the new franker cartridge. Make sure the top of the metal plate fits into the slot in franker cartridge (as pictured).
5. Secure the franker cartridge:
 - a. Push the metal plate towards the body of the scanner (pushing in the franker cartridge).
 - b. Lowering the blue latch over the franker cartridge until it snaps closed.
6. Replace the scanner cover.

Click here to view video: [How to Install Franker Cartridge](#)

Alternatively visit: <https://www.youtube.com/user/RDMCorporation/playlists>

Installing the endorser inkjet cartridge

When you place the new inkjet cartridge into the holder, make sure that you insert it at the angle described in the following steps. If you do not insert the cartridge properly, it might not make contact with the document when it is scanned.

1. Remove the endorsement printer cover.
2. Pull the inkjet latch away from the inkjet cartridge (as pictured).



3. Pull the inkjet cartridge out of the scanner.
4. To insert the new inkjet cartridge, pull the inkjet latch back and place the inkjet cartridge into the holder. The cartridge needs to be at an angle so that the back of the cartridge is lower than the front of the cartridge.
5. Push the cartridge down into the holder until the cartridge snaps into place.
Once installed, the inkjet cartridge sits on a slight angle with the back of the cartridge lower than the front.
6. Make sure there is no gap between the inkjet cartridge and the endorsement channel.
7. Replace the endorsement printer cover.



Click here to view video: [How to Install Inkjet Cartridge](#)

Alternatively visit: <https://www.youtube.com/user/RDMCorporation/playlists>

Replacing the inkjet blotter

Scanners with endorsement printers include an inkjet blotter that absorbs excess ink from the endorsement process. Over time, the blotter might stop absorbing ink effectively and so should be replaced. Scanners with endorsement printers come with five replacement blotters.

To replace the inkjet blotter:

1. Remove the front cover of the scanner.
At the back of the scanner, above the franker cartridge, you can see the top of the inkjet blotter, as shown below:
2. With your finger or tweezers, remove the inkjet blotter from its slot.
3. Dispose of the used blotter.
4. Insert the replacement inkjet blotter into the slot.

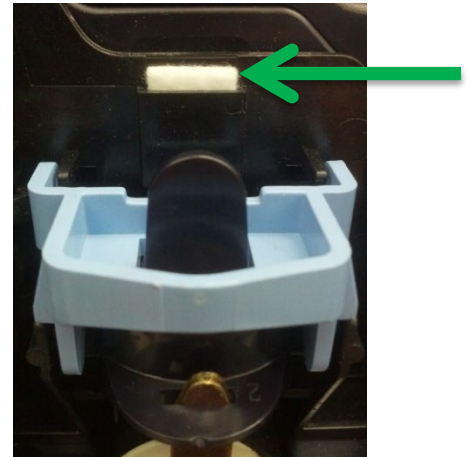

Replacing the paper roll for the printer

If your scanner has a printer, the following steps describe how to replace the paper roll.

1. Press the printer door release button and completely open the printer door.
2. Remove the empty paper roll from the paper compartment.
3. Insert the new paper roll into the compartment, with the end of the paper roll rolling from the top.
4. Pull the paper out of the compartment and close the printer door so that the end of the paper sticks out of the compartment (as pictured). Push the door closed in the center of the printer door.

Make sure the cover is completely closed. If you push the cover from the sides, the cover might not close completely. When closed correctly, both sides of the printer cover are flush with the scanner.

5. Rip off any access paper sticking out of the printer cover.



Cleaning your scanner

RDM recommends that you periodically clean the scanner to remove dust, ink and debris build-up to ensure optimal performance and extended scanner life.

There are two ways to clean your RDM scanner:

1. Using the **RDM ScannerCare Cleaning Kit**, which includes WaffleTechnology™ cleaning cards and device wipes:
 - You can use the RDM ScannerCare application which is installed on your computer or your payment application's document feeding cycle as described below.
2. **Manually**, by follow instructions provided in *Manual cleaning* on page 29.

Using RDM ScannerCare Cleaning Kit

Cleaning the scanner with the RDM ScannerCare application

1. Run the ScannerCare program:
 - search your computer for “ScannerCare” and run the ScannerCare application.
2. Select the “ScannerCare” tab.
3. Select the “Clean scanner” sub-tab.

Here is the “Clean scanner” sub-tab

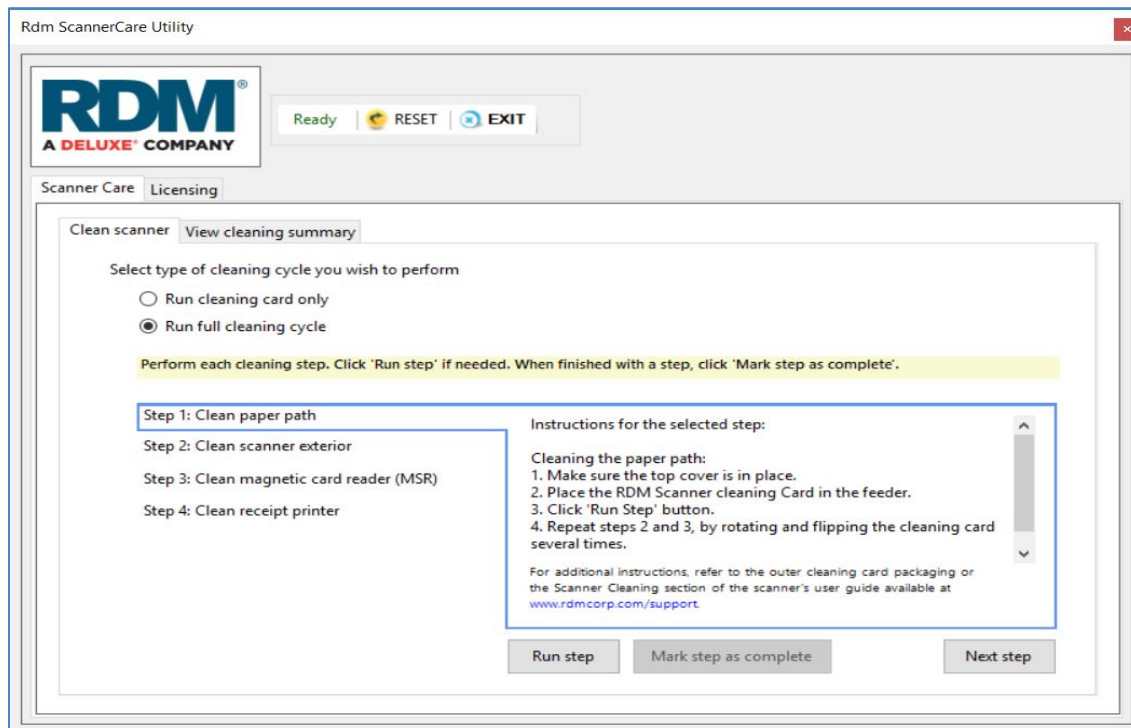

4. Choose to run either the cleaning card only or run a full cleaning cycle.
5. Perform each step. Click on each step as needed and follow the instructions.
 - a. Click the “Run step” button to begin the step.
 - b. When the step is completed, click the “Mark step as complete” button.
 - c. Click on either the next step, or the “Next Step” button to advance to the next step.
 - d. Continue until all steps are completed.
6. Select the “View cleaning summary” sub-tab.
7. View the cleaning summary for the scanner. The summary shows various information related to each scanner cleaning step.

Here is the “**View cleaning summary**” tab for the EC9100i:

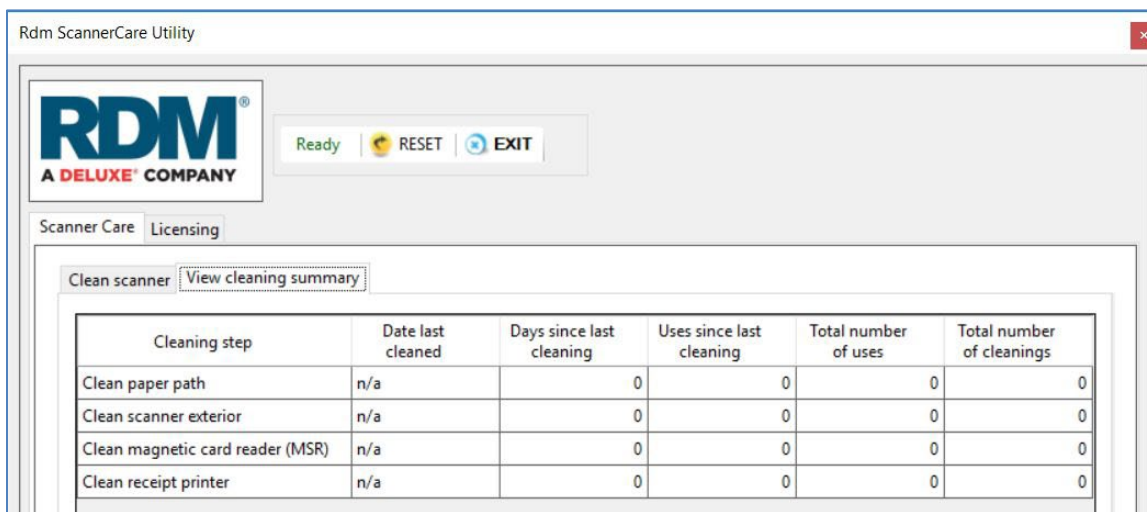

Cleaning step	Date last cleaned	Days since last cleaning	Uses since last cleaning	Total number of uses	Total number of cleanings
Clean paper path	n/a	0	0	0	0
Clean scanner exterior	n/a	0	0	0	0
Clean magnetic card reader (MSR)	n/a	0	0	0	0
Clean receipt printer	n/a	0	0	0	0

Cleaning the scanner with the document feeding application

1. Start a document feeding application.
2. Run the cleaning card through the RDM scanner several times, rotating the card top to bottom on both sides.
3. Cancel the application, discard the used cleaning card.

Manual cleaning

Scanners perform best when all working surfaces are clean and free of foreign material.

Caution:

- Always disconnect the scanner from its power source before manual cleaning.
- Solvents or harsh cleaners might damage or discolor the cabinetry.

Cleaning the outside cabinetry

Use a damp cloth and mild soap.

Cleaning the inside of the scanner unit

1. Remove the front cover and the endorsement printer cover.
2. Use a dusting brush designed for use with electronic equipment or a compressed air duster to clean inside the scanner.
3. Replace the covers.

Cleaning the image sensor

Caution: Always disconnect the unit from its power source before cleaning the image sensor.

1. Remove the front cover and the endorsement printer cover.
2. Open both the front and back panels that cover the image sensor.
The front panel can open up to 90°. The back panel opens only a few degrees.
3. Use any of the following to gently remove any ink or dust from the image sensor.
 - A lens cleaning tissue.
 - A damp lint-free cloth.
 - A cotton swab dampened with rubbing alcohol.
4. Clean the glass on each panel thoroughly.
5. Replace each of the covers.



Troubleshooting

During everyday operations, you might encounter minor malfunctions with RDM EC9100i series scanners. Before calling for service, review the troubleshooting steps below.

Scanner does not respond

1. Ensure the cable that connects your scanner to your computer is properly connected to the correct port on the back of the scanner and computer (according to instructions provided by your distributor).
2. Make sure that the correct power cord is connected to the unit. If your power cord has an on/off switch, make sure the switch is in the “on” position. Change or replace the cord, if necessary.
3. If the problem persists, contact your solution provider or help desk.

Card transactions do not function properly

1. Ensure that you are swiping the card properly.
The black magnetic stripe on the back of the card must face downward and towards the body of the scanner.
2. Try using another card to ensure the first card was not defective.
3. If the problem persists, contact your solution provider or help desk.

Printer does not print

1. Ensure you are using 3” Thermal printer roll (see 34)
2. Ensure that the printer has not jammed.
3. Ensure that the end of the paper rolls from the top of the roll.
4. Ensure that the printer door is completely closed.
5. If the problem persists, contact your solution provider or help desk.



Specifications

Physical dimensions		
Depth: Min: 237mm (9.3") <i>(with retracted extensions)</i> Max: 311mm (12.25") <i>(with fixed extensions)</i>	Width: Standard Models: 154mm (6.0") MSR Models: 157mm (6.2")	Height: Standard Models: 175mm (6.9") Receipt Printer Models: 245mm (9.65")
Document feed capacities		
Preferred paper weight: 20 lb. to 32 lb.	Height: Min: 50.8mm (2") Max: 101.6mm (4")	Length: Min: 101.6mm (4") Max: 228.6mm (9")
Single-feed models	EC9111/12	Single document.
Auto-feed models (<i>multi-feed</i>)	EC9103/04/08	Up to 30 documents (based on document thickness & condition)
Document collection pocket	Up to 60 documents. (based on document thickness & condition) Maintains the integrity of the order of the original source documents.	
Technical features		
MICR reader	E13B or CMC7 MICR Fonts. OCR E13B MICR Assist available. Uses RDM's Progressive MICR Method for optimum MICR read accuracy.	
Image capture	Duplex imaging. File formats: Tiff 6.0, JPEG, BMP (uncompressed). File compression: JPEG grayscale (Quality 25), CCITT Group 4 (ITU T.6) (or no compression) for bi-level. Documents and ID cards: 100 or 200 DPI grayscale or bi-level	
Image processing	Up to 4 images, any combination, front and back for documents or ID cards. Resolutions for documents: 100, 200 DPI grayscale or bi-level Resolutions for ID cards: 200 or 400 DPI image resolution. (V-scan captured at 200DPI)	
Identification (ID) card imager	Integrated Duplex Imaging. 54mm [2.13"] (V) x 86mm [3.39"] (H)	
Image Quality Assurance (IQA)	IQA includes: too light/too dark /skew (Bi-Level Images Only).	
Magnetic Stripe Reader (MSR) (select models)	Integrated 3-track, bi-directional, alphanumeric, encryption capable MSR.	
Optical character recognition (optional license)	Under application control Alphanumeric OCR A and B font recognition of OCR code-lines for applications such as bill payment.	

Franker	Under application control a fixed text message “Electronically Presented” can be stamped on the front of a document, in red ink.
Inkjet Endorsement printer (select models)	Under application control, a single line 1/8” high text message can be printed on the rear of a document. HP C6602A inkjet cartridge required.
Scanner status LED	Provides the unit’s status via illuminated LED.
USB port	High Speed USB 2.0 (480 mbps) on all models.
Receipt Printer (select models)	Integrated 3” thermal receipt printer. Clamshell paper load. Paper width 80mm (3.15”). Print width 71mm (2.8”). Maximum print speed of 170mm/sec (6.7”/sec). Uses power from scanner’s power supply.
Software and support	
Supported operating systems	Windows 10 (32/64-bit).
Development software	RDM EC Scanner Application Development Kit (ADK) includes RDM SCI API components, USB driver, Redistributable Installation Packages and Sample Applications.
3rd Party Certifications / Licenses	Silver Bullet Technologies: Ranger™ for RDM Plug-in
Environment	
Operating temperature	10 to 40 Degrees C (50 to 104 Degrees F).
Operating humidity	10 to 85% relative humidity (non-condensing).
Power Rating	
Unit input (24VDC)	Standard Models: 900mA. Receipt Printer Models: 2.5A.
Power supply input range	100–240V, 50/60 Hz.
Other	
Certifications	Industry certifications including. WHQL certified USB driver IEC 60950-1 (Product Safety) FCC Part 15,Subpart B, Class A - Unintentional Radiators (EMC)
Warranty	2-year standard warranty.
Life expectancy	5 years under normal usage.

Consumables and accessories	
	RDM Part number
Replacement franker cartridge – “Electronically Presented” red ink <i>(sold separately)</i>	6000-6065
Replacement HP inkjet printer cartridge <i>(sold separately)</i>	6000-6060 (HP C6602A) – black ink
Ink Jet Blotter - 5 pack	302987
Thermal paper roll 3.125" W x 225' L (3.125" maximum diameter)	Standard thermal roll paper available from office supply stores
Replacement power adapter and cord	302843 – Standard models 303811 – Receipt Printer models
USB 2.0 cable, A to B male, shielded, 2m (black)	6000-6106

Warranty Information

LIMITED WARRANTY:

RDM EC9100i is warranted against defects in materials and workmanship under normal use and service for a period of two years after the date of receipt by you. This warranty is extended only to the original purchaser. Extended warranty programs might be offered by your solution provider.

The entire liability of RDM Corporation (the Corporation), distributors of the RDM EC9100i scanner and manufacturers of auxiliary equipment used with the RDM EC9100i and your exclusive remedy shall be, at the Corporation's option either (a) return of the price paid, or (b) repair or replacement of the RDM EC9100i scanner that does not meet the limited warranty and which is returned to the Corporation with a purchase receipt or other proof of date of original purchase which will be required in order to exercise your rights under this warranty.

The limited warranty is void if failure of the RDM EC9100i has resulted from accident, abuse or misapplication. Any replacement RDM EC9100i will be warranted for the remainder of the original warranty period.

The equipment is sold with the understanding that neither the Corporation, such distributors nor such manufacturers will be liable for any damages whatsoever (include, without limitation, direct or indirect damages for personal injury, loss of business profits, business interruption, loss of business information, or any other pecuniary loss) arising out of the use of or inability to use the RDM EC9100i, even if the Corporation, such distributors and/or such manufacturers have been advised of the possibility of such damages.

In any case, the entire liability of the Corporation, such distributors and such manufacturers with respect to the RDM EC9100i shall be limited to the amount actually paid by you for the RDM EC9100i. The Corporation, such distributors and such manufacturers disclaim all other warranties, express or implied, including, without limitation, implied warranties of merchantability and fitness for a particular purpose with regard to the RDM EC9100i and the accompanying written materials.

WARRANTY SPECIFICS:

This warranty only covers failures due to defects in materials or workmanship, which occur during normal use.

It does not cover the following:

- Damage, which occurs in shipment;
- Failures which are caused by products not supplied by RDM;
- Failures which result from accident, misuse, abuse, neglect, excessive dirt or dust cause by lack or preventative maintenance measures, mishandling, misapplication, alteration or modification;
- Service by anyone other than RDM;
- Damage that is attributable to acts of nature including but not limited to:
 - Flood, lightning, power surge or static electricity, water damage, fall, theft, or vandalism;
 - Spillage of liquid or objects that have fallen into the equipment;
 - Equipment that has been exposed to excessive heat or unstable environmental conditions;
 - Consumables such as Franker Roller or Franker Assembly, or other RDM EC9100i consumables or accessories such as cables.

RDM scanner units with problems found to be caused by incorrectly set configuration parameters (IRN#, Owner Code, Merchant ID, etc.) are not considered defective and will not be serviced under warranty. Warranty is void if any of the external case of the unit has been opened or removed or the unit has, in RDM's opinion, been damaged through misuse or improper care.

Units returned to RDM for warranty repair will be reconfigured with factory defaults and returned to customers.

RDM and its authorized service depots reserve the right to charge a fee for scanners found to be problem free "No Trouble Found".



RDM Network Scanner Series

EC9700i / EC9600i

User Guide



January 2021

Copyright

Copyright ©2021 by RDM Corporation.

All rights reserved. No part of this publication may be reproduced, stored in a retrieval system, or transmitted, in any form or by any means, electronic, mechanical, photocopy, recording, or otherwise, without the prior written permission of RDM Corporation.

Trademarks

RDM, ITMS, Simply Deposit, Simply Deposit Mobile, Dynamic Decisioning Portal, DepositWatch+, QCX, QCV, EC6000i, EC7000i, EC7500i, EC9000i, EC9100i, EC9600i and EC9700i are trademarks or registered trademarks of RDM Corporation. All other brands and their products are trademarks or registered trademarks of their respective holders and should be noted as such.

Disclaimer

RDM Corporation makes no warranty with respect to the adequacy of this documentation, programs, or hardware that it describes for any particular purpose or with respect to the adequacy to produce a particular result. In no event shall RDM be held liable for special, direct, indirect, or consequential damages, losses, cost, charges, claims, demands, or claim for lost profits, fees, or expenses of any nature or kind.

RDM, By Deluxe

www.rdmcorp.com

End-User/Customer Agreement

Please read the end-user/customer agreement regarding software license and warranty terms during the installation of the application.

Compliance statements

FCC Compliance Statement

This equipment has been tested and found to comply with the limits for a Class A digital device, pursuant to Part 15 of the FCC rules. These limits are designed to provide reasonable protection against harmful interference when the equipment is operated in a commercial environment. This equipment generates, uses, and can radiate radio frequency energy and, if not installed and used in accordance with the instruction manual, may cause harmful interference to radio communications. Operation of this equipment in a residential area is likely to cause harmful interference in which case the user will be required to correct the interference at his own expense.

Warning: Changes or modifications not expressly approved by RDM Corporation could void the user's authority to operate the equipment.

All units covered by this manual have no user-serviceable parts inside. In the event repairs are ever needed to any RDM product, they should be performed by RDM Corporation or an authorized representative of RDM Corporation. For information please contact RDM Corporation, 619A Kumpf Drive, Waterloo, Ontario, Canada N2V 1K8, at 1-800-567-6227, or RDM's US service agent below.

US Service Agent
Kortney Nordrum
(651)-490-8614
compliance@deluxe.com

Contents

Copyright	2
Compliance statements.....	3
Contents	4
About this guide.....	6
Introduction.....	7
Your Scanner	8
Scanner Models.....	8
Status LED Signals	10
RDM network scanners	11
Single-feed (SF) models	11
Auto-feed (AF) models	12
Auto-feed (AF) printer models.....	13
Internal components	14
Inside the front cover - side view – Auto-Feed	14
Inside the front cover - side view – Single-Feed	14
Inside the front cover - back view	15
Inside the front cover and endorsement printer cover - top view.....	16
Connection ports	17
Setting up your scanner	19
Connecting the power cord.....	20
Disconnecting the power cord.....	20
Installing cartridges and paper roll.....	20
Connecting the RDM network scanner	21
Adding the scanner to the network.....	23
Operating the scanner	24
Preparing documents.....	24
Feeding documents	24
Single-feed (SF) models.....	24

Auto-feed (AF) models	25
Swiping magnetic stripe cards (MSR models).....	25
Imaging identification cards	25
Understanding light signals.....	26
EC9600i network scanner signals	26
EC9700i network scanner signals	27
Maintaining your scanner.....	28
Removing the covers	28
Front cover	28
Endorsement printer cover	28
Franker and endorser inkjet cartridges	29
Installing the franker cartridge.....	30
Installing the endorser inkjet cartridge	31
Replacing the inkjet blotter	32
Replacing the paper roll for the printer.....	32
Cleaning your scanner.....	33
Using RDM ScannerCare Cleaning Kit.....	33
Manual cleaning	34
Troubleshooting.....	36
Scanner does not respond.....	36
Card transactions do not function properly	36
Printer does not print	36
Can't connect to network scanner	37
Network Scanner Dashboard	38
Testing the network scanner	40
Restoring factory default settings	41
Specifications.....	42
Warranty Information	45
LIMITED WARRANTY:.....	45
WARRANTY SPECIFICS:	46

About this guide

This guide describes the RDM network series scanners (EC9600i and EC9700i), some basic operations, and how to maintain your scanner. For instructions on how to use your scanner with your payment application, contact your solution provider.

Requirements

The scanner is for indoor use only. Keep the scanner dry; avoid areas of high humidity.

Do not remove any parts from areas that are not described in this guide. Removing parts from areas not described in this guide will void the warranty.

When you are working inside the scanner, such as when you are replacing the franker or endorser cartridge, make sure the scanner's power is disconnected.

Recommendations

Record all distributor contact information for future reference.

Save the original box and packing material and reuse them if the unit must be shipped to a new location or returned for service.

Position the unit so that the operator has easy access to the document path and a clear view of the LED. Do not put the unit close to a heat source, in direct sunlight, or close to any device that can emit electromagnetic interference, such as a computer monitor or power adapter.

The scanner is not suitable for use in locations where children are likely to be present.

Introduction

The RDM EC9600i and EC9700i network series scanners, herein referred to as RDM network scanners, provide affordable functionality in a compact, efficient design. Featuring RDM's industry leading Progressive MICR Method, the RDM network scanners deliver optimum magnetic (MICR) and optical (OCR) read rates on E13B characters. Additionally, the scanners produce superior image quality to maximize recognition rates for machine printed and hand-written characters on checks, remittances and ID cards such as driver licenses.

With several models and feature options to choose from, RDM network scanners are an ideal fit for payment applications such as remote deposit capture, remote lockbox, check cashing, teller capture, branch back-counter capture, healthcare POS, retail POS, and walk-in bill payments. The scanners are available in single-feed and auto-feed (multi-feed) models and offer a range of document throughput options and configurations. All models include an integrated ID card imager.

Additionally, the RDM network scanners provide IP addressability over USB and Ethernet. Embedded software enables easy plug-and-play connectivity eliminating the need for the installation of device drivers or other utility software. The scanners can be used as a standalone device or shared network resource that works with workstations, terminals, or mobile devices; can be used with Microsoft Windows, Apple macOS and iOS, and Linux operating systems; and is compatible with virtual desktop/thin client (e.g. Citrix) and virtual machines (e.g. VMware Horizon) environments.

To accommodate applications such as walk-in bill payments, the EC9600i series can be licensed for OCR A and B font recognition capability. You can tell if your EC9600i scanner is licensed for OCR by the silver label (see page 9) on the bottom or back of the scanner, depending on the model. All EC9700i series scanners include recognition capability for OCR A and B, and optionally PDF 417 (for driver licenses). Please contact your reseller for questions specific to OCR capabilities of your scanner.

Your Scanner

Scanner Models

The following table lists the available EC9600i and EC9700i network series models and general feature comparison. Model and feature availability may vary. Check with your scanner provider.

	Single-Feed	Multi-Feed	E13B Recognition*	Franker Enabled	Ink-jet Endorser Enabled	Document feeder capacity	Document Throughput (DPM)	ID Card Imager	Magnetic Stripe Reader (MSR)	3" Thermal Receipt Printer	Other Recognition Capabilities
EC9611 SMB	•		Optical			1	30	•			OCR A/B Lic.
EC9611f SF	•		MICR / OCR Assist	•		1	30	•			OCR A/B Lic.
EC9612f SF	•		MICR/ OCR Assist	•		1	30	•	•		OCR A/B Lic.
EC9613f SF	•		MICR/ OCR Assist	•	•	1	30	•			OCR A/B Lic.
EC9603f AF		•	MICR/ OCR Assist/ OCR Assist	•	•	30	30	•			OCR A/B Lic.
EC9604f AF		•	MICR/ OCR Assist	•	•	30	30	•	•		OCR A/B Lic.
EC9608f AF		•	MICR/ OCR Assist	•	•	30	30	•	•	•	OCR A/B Lic.
EC9703f AF		•	MICR / OCR Assist		•	60	100	•			OCR A/B PDF 417

***Note:** All scanner models (except EC9611 SMB) perform E13B recognition magnetically (MICR) and use optical assist (OCR on E13B) for unrecognizable characters. The EC9611 SMB only uses optical recognition (OCR on E13B). Both methods deliver optimum read rates at or above industry standards.

There is a label on your scanner that includes the following details about your scanner:

- The scanner's model number
- MAC address
- The scanner's serial number
- The speed of your scanner (30 documents per minute in the example below)
- Whether the scanner is licensed for OCR (only EC9600i has optional OCR License and will be noted on the label - the example below is not licensed for OCR recognition)

You can locate your scanner's label on the bottom or back of your scanner, depending on the model.

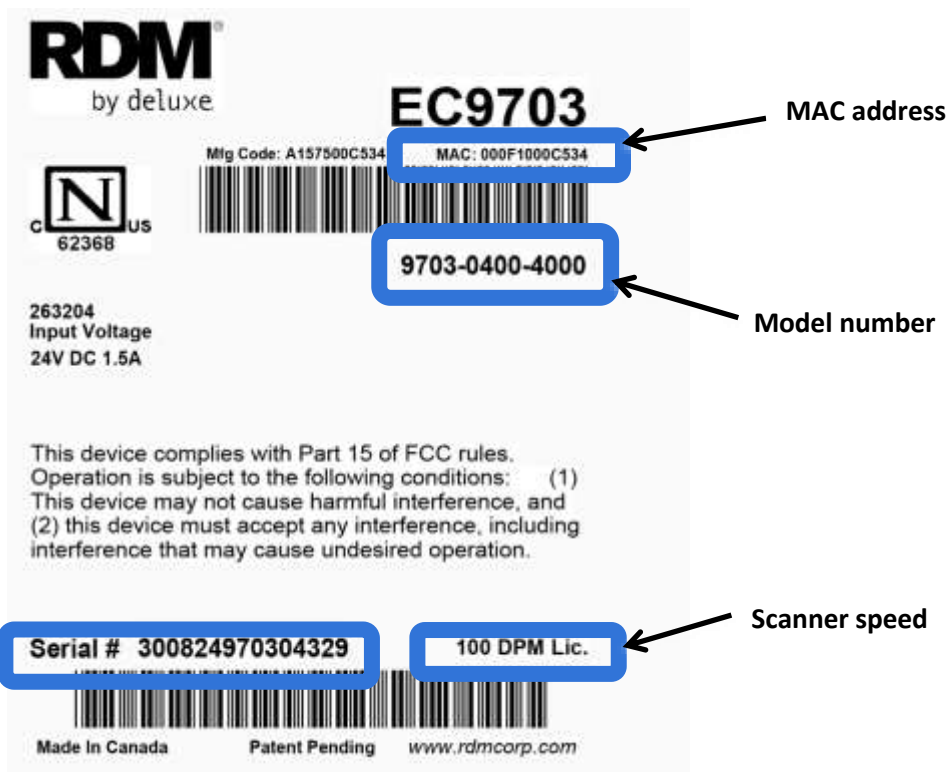

Status LED Signals

This status L.E.D. (Light Emitting Diode) is located on the front right of the scanner. The light indicates the status of the scanner. For more information, see Understanding light signals on page 26.



RDM network scanners

Single-feed (SF) models

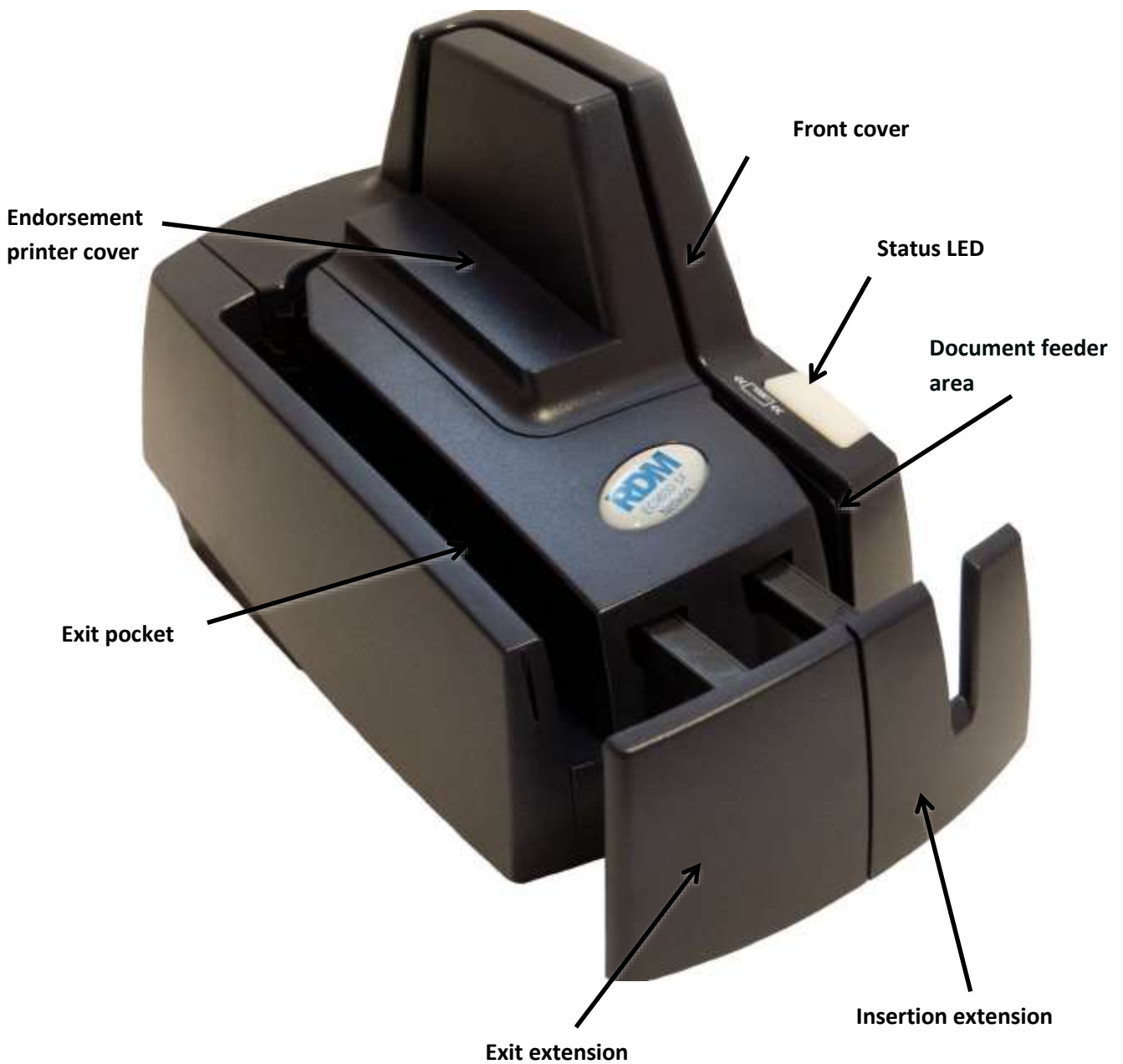

Auto-feed (AF) models



Auto-feed (AF) printer models



Internal components

Inside the front cover - side view – Auto-Feed

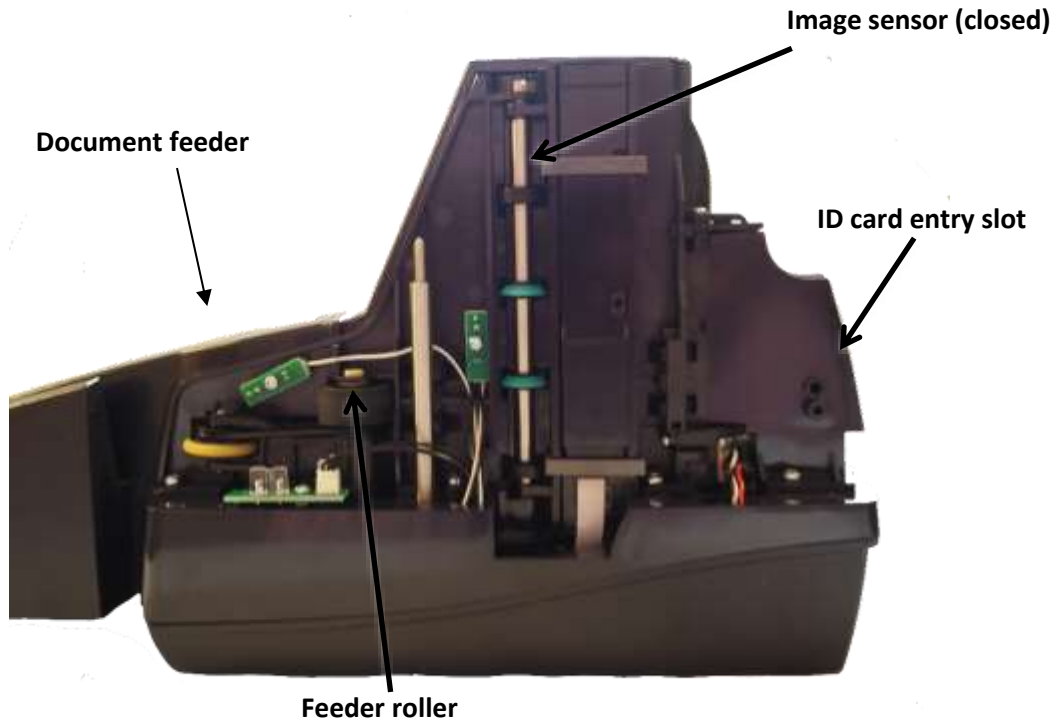

Inside the front cover - side view – Single-Feed

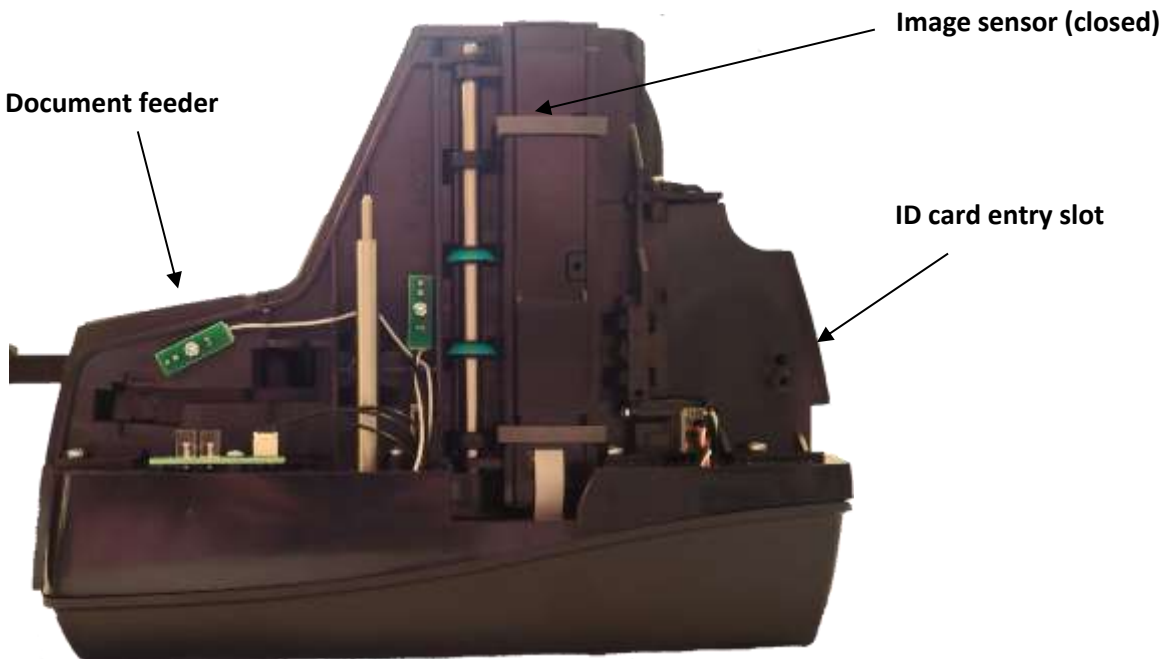

Inside the front cover - back view

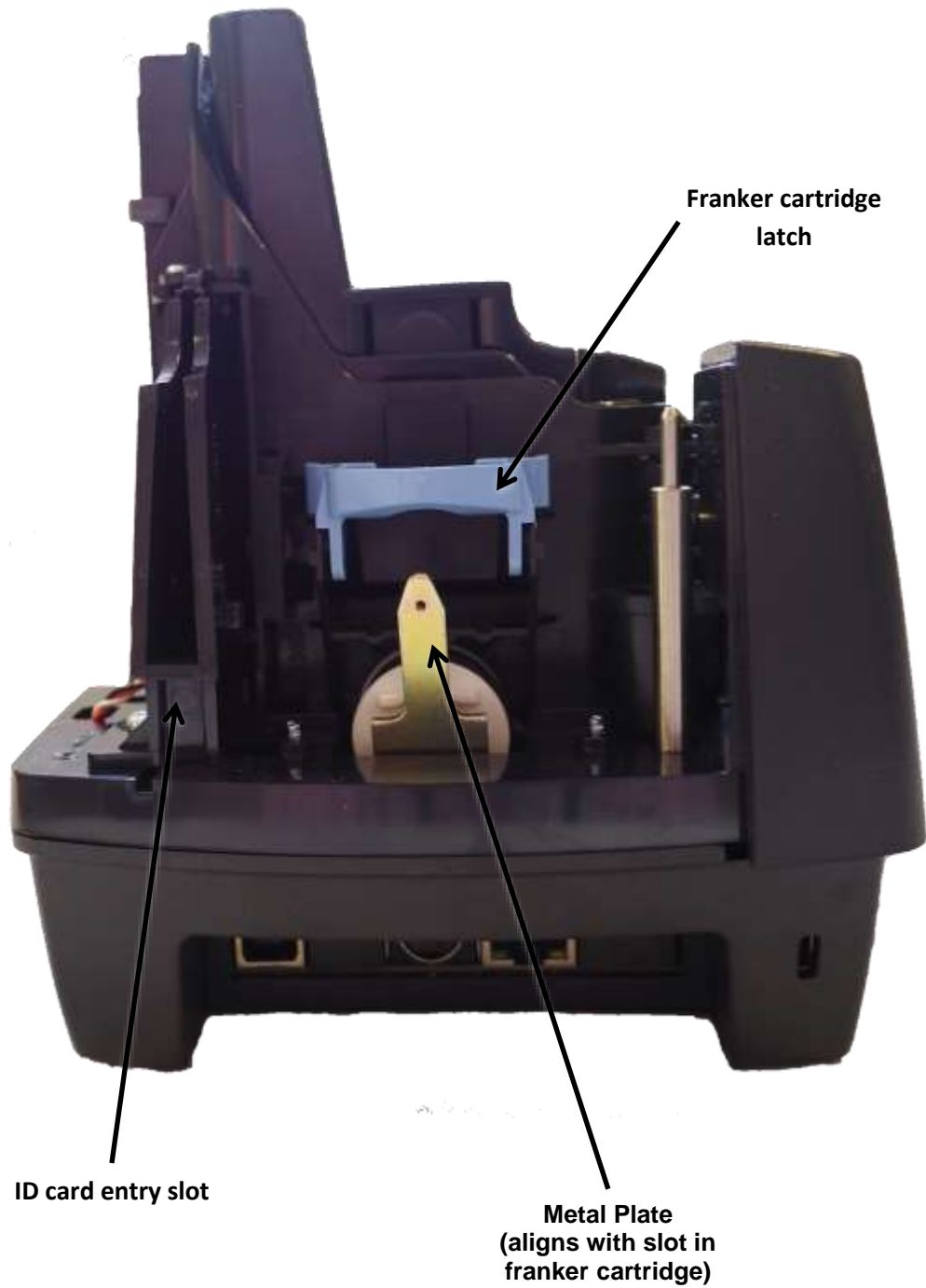

Inside the front cover and endorsement printer cover - top view

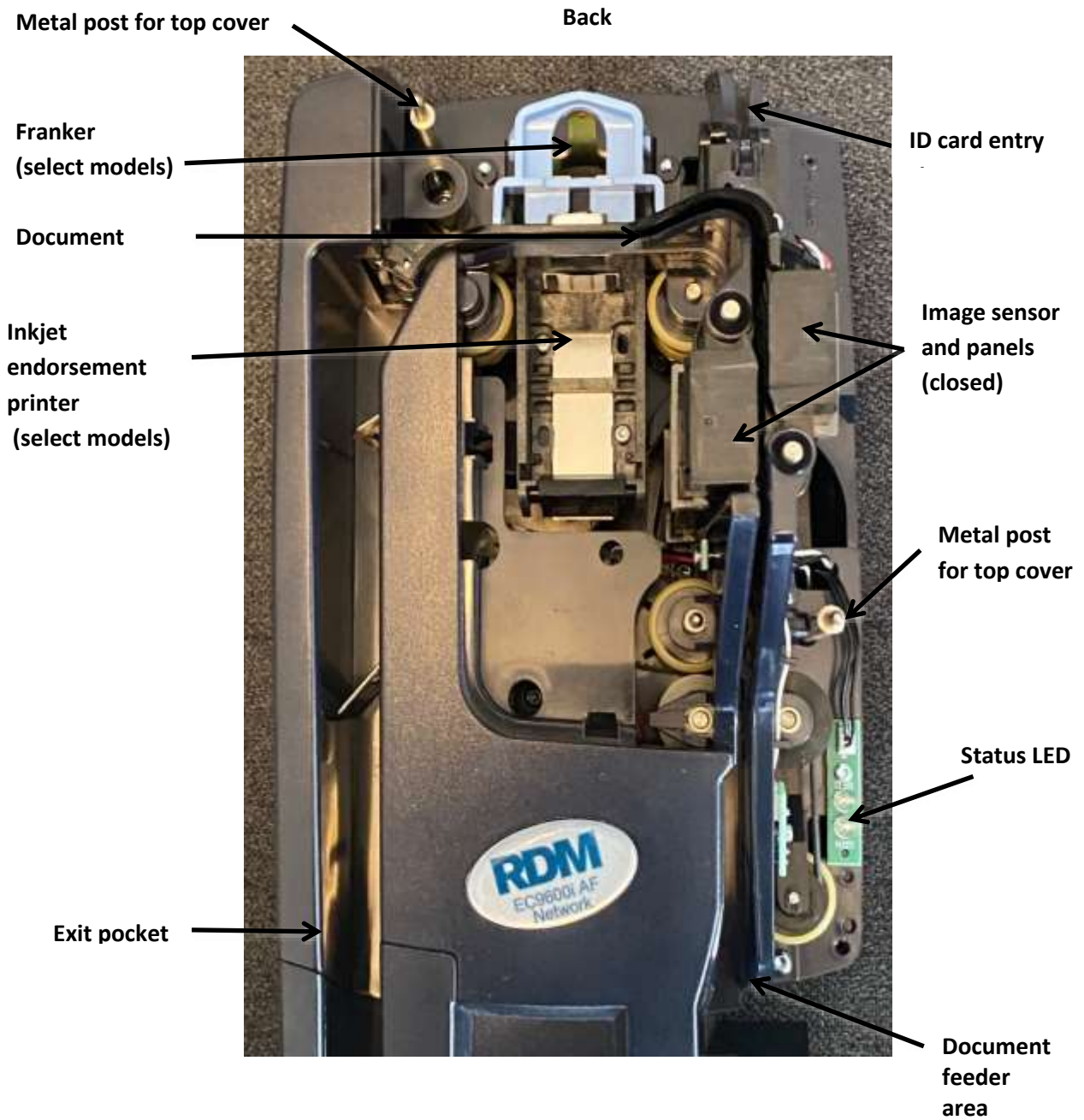

Connection ports

EC9600i AF models



USB

Power

Ethernet 10/100 Switch

EC9600i SF models



USB

Power

Ethernet 10/100

EC9600i SMB models



USB

Power

EC9700i AF models



USB

Ethernet 10/100/1000

Power

* **Note:** Not all scanner models include every item shown in the diagrams.

Connector/Port	Description		
USB Port	High-speed 2.0 (480 mbps). Use this port to connect to a computer. You must use the USB A to B cable.		
Power	Connect the power adapter to this port.		
K-Slot EC9600i models only	The K-Slot or Kensington® Security Lock lets you secure the unit with a cable (not provided) that locks into the slot. Cables can be purchased from your local computer supply store.		
Ethernet Port(s)		EC9600i models	EC9700i models
	SMB (Single-Feed)	0	n/a
	SF (Single-Feed)	1	n/a
	AF (Auto-Feed)	2	1

Setting up your scanner

To set up your scanner:

- Choose a location.
- Unpack the shipping box.
- Inspect the scanner's features.
- Insert the franker cartridge (sold separately).
- Insert the inkjet endorsement printer cartridge (sold separately).
- Insert the receipt paper roll, if one is included with your scanner.

Choosing a location

Locate your scanner in a place that:

- Has a flat surface, such as a counter top or table.
- Is convenient for the scanner operator.
- Offers adequate ventilation and protection from elements such as heat, dust, oil, or moisture.
- Is close to the application computer. Depending on your scanner model, a USB 2.0 high speed or Ethernet connection is required.
- Is close to an electrical outlet.

Unpacking the shipping box

1. Open the top of the box.
2. Remove and unwrap the items. Lift the scanner out of the box from the bottom of the scanner.
3. Save the box and packing material for future use.

The shipping box includes the following items:

- Scanner
- USB cable (A to B)
- Ethernet cable (except EC9611 SMB)
- Power adapter
- 5-pack inkjet blotter (models with inkjet endorsement printer)
- 3" thermal receipt paper roll (models with receipt printer)
- Cleaning card sample
- Quick Start Guide

Connecting the power cord

1. Align the flat side of the power connector so that it is facing up.
2. Insert the round end of the power cord into the power port on the back of the scanner until it clicks into place.

Note: Although the status light on the scanner might illuminate without the power cord being fully connected to the scanner, **you must push the power cord until it clicks into place for the scanner to function correctly.**

3. With the power cord connected to the power adapter, plug the other end of cord into an electrical outlet.
4. If your power cord has an on/off switch, make sure the switch is in the “on” position.



Click to view video: [How to connect your EC9600i Network Auto Feed check scanner](#)

Click to view video: [How to connect your EC9600i Network Single Feed check scanner](#)

Alternatively visit: <https://www.youtube.com/user/RDMCorporation/playlists>

Disconnecting the power cord

Caution: Disconnecting the scanner from a power source while the scanner is processing a transaction might cause data loss.

The power cord has a sleeve on it that secures it to the unit. The security sleeve prevents the power cord from being pulled out of the unit accidentally.

1. Hold the unit in place with one hand to prevent the unit from falling.
2. With your other hand, slide the power cord security sleeve back and pull the power cord free of the scanner.

Installing cartridges and paper roll

For installing the franker cartridge, see *Installing the franker cartridge on page 30*.

For installing the endorser inkjet cartridge, see *Installing the endorser inkjet cartridge on page 31*.

For installing the paper roll, see

Replacing the paper roll for the printer on page 32.

RDM network scanner payment application requirements

The RDM network scanners do not require you to install any drivers on your computer. However, depending on your payment application (i.e. does it support the scanner's plug and play capabilities), there might be some additional setup required for the application to connect to the scanner. For example, you might need to:

- Install a security certificate on your computer,
- Make changes to your browser's security settings,
- Enter your scanner's IP address or serial number into the payment application,
- Configure or select your scanner make/model in the payment application.

For more information about RDM network scanner setup requirements, see your payment application's documentation.

Connecting the RDM network scanner

The RDM network scanner can connect to your computer via USB Cable or by Ethernet Cable.

There are three types of connection configurations depending on your model.

Connectivity Options	Single-Feed SMB	Single-Feed	Auto-Feed
1. USB: Scanner is connected to the computer using USB cable	•	•	•
2. Ethernet: Scanner and computer have separate connections to the network		•	•
3. Ethernet Switch: Computer is connected to the network through the scanner (EC9600i AF series models only)			•

Option 1. USB: Scanner is connected to the computer using USB cable

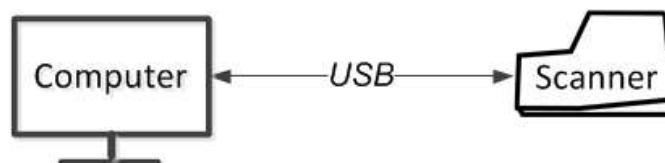

Considerations:

- The only workstation that can use the scanner is the one it is connected to.
- Does not require a dedicated Ethernet connection for the scanner.
- Can be used by both auto-feed and single-feed network scanners.
- EC9611 SMB model uses this option only.

To connect:

Plug the USB cable (included) into the square USB port on the back of the scanner (marked in red below) and plug the other end into a USB port on your computer

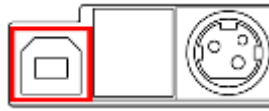

Option 2. Ethernet: Scanner and computer have separate connections to the network

In this configuration, you connect the scanner to the network. Your computer retains whatever network connection it had previously.

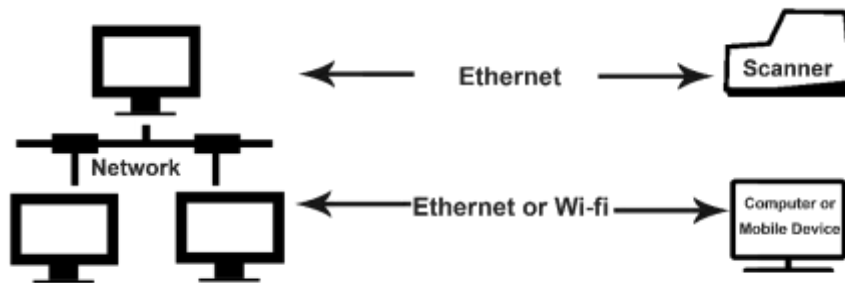

Considerations:

- All workstations on the same network can connect to the scanner.
- Requires a dedicated Ethernet connection for the scanner.
- Can be used by network scanners with at least one Ethernet port.

To connect:

1. Plug an Ethernet cable into the Ethernet port on the back of the scanner (marked in red below) and plug the other end into an Ethernet network jack. (Plug Ethernet cable into one of the two ports on EC9600i AF models).

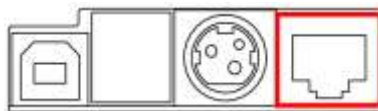

Option 3. Ethernet Switch: Computer is connected to the network through the scanner (EC9600i AF series models only)

In this configuration, you connect the scanner to the network and then connect your computer to the network through the scanner.



Considerations:

- For EC9600i AF models only: EC9603f, EC9604f, EC9608f
- All workstations on the same network can connect to the scanner.
- Does not require a dedicated Ethernet connection for the scanner
- The computer that connects to the network through the EC9600i AF network scanner is limited to a 100 MB/s connection.

To connect:

1. Disconnect the Ethernet cable that is plugged into your computer and connect it to the scanner in one of the two Ethernet ports (marked in red below).
2. Using the Ethernet cable that is included in your scanner box, connect one end to the other Ethernet port on the back of your scanner (marked in red below) and the other end into the Ethernet port on your computer.

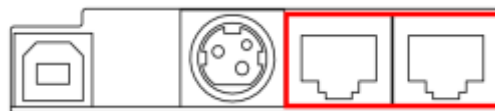

Adding the scanner to the network

Depending on your network's security settings, an administrator might need to add the scanner to the network. The administrator will need the scanner's MAC address and device name:

- The MAC address is printed on the bottom or back of the scanner. (See Label on page 9)
- The scanner's device name is `rd<scannerserialnumber>`. For example, `rd2807059603021`. The serial number is printed on a silver label on the bottom or back of your scanner.

Operating the scanner

Caution: Do not open the cover or try to access the inside of the scanner while it scans a document.

Preparing documents

To reduce the possibility of errors and damage to the unit:

- Remove all folds and creases in the document.
- Remove any paper clips and staples from the document.
- Make sure that documents are not stuck together.
- Make sure that documents are dry.

Feeding documents

The scanner unit is ready to accept documents when the LED is flashing green. Insert the documents either one at a time with single-feed (SF) models, or in a batch with auto-feed (AF) models.

Make sure that you place the documents into the feeder with the MICR line at the bottom and facing towards the outside of the scanner.

Caution: Adjust the exit extension or the pocket stop to fit the documents that you are scanning. Documents can be damaged or jam in the scanner if the exit extension or pocket stop is not fitted to the documents.

Single-feed (SF) models

1. Start the scanning process. For example, click Scan on your payment application.
2. Hand-feed a document into the feeder until the scanner pulls the document through the transport. The document is scanned and processed.
3. Repeat steps 1 and 2 until you have scanned all your documents.



Click to view video: [Feeding Checks on an RDM Single Feed Check Scanner](#)

Alternatively visit: <https://www.youtube.com/user/RDMCorporation/playlists>

Auto-feed (AF) models

Place documents into the document feeder.

- i. EC9600i AF maximum documents = 30
- ii. EC9700i AF maximum documents = 60

Note: Do not push documents past the check icon on the right side of the document feeder in order to prevent document jams.

2. If you are required to do so, start the scanning process. For example, click Scan on your payment application.

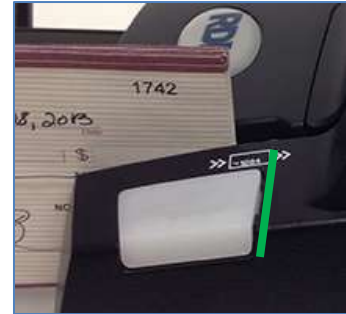

Click to view video: [Feeding Checks on an RDM Auto Feed Check Scanner](#)

Alternatively visit: <https://www.youtube.com/user/RDMCorporation/playlists>

Swiping magnetic stripe cards (MSR models)

1. Place the card in the slot on the side of the scanner with the stripe down and facing towards the body of the scanner.
2. Swipe the card from front to back.



Imaging identification cards

The ID imager uses the same track as the document scanner, but you insert ID cards at the back of the scanner. Insert the card into the scanner so that the front of the ID card faces away from the scanner. The ID imager scans both the front and back of the identification card.

1. Insert the identification card into the back of the scanner track until you feel the scanner pinch the card. The scanner pulls the card through the track.
2. Remove the card from the front of the scanner track.



Understanding light signals

The scanner's status is shown through a single, multistate LED (light-emitting diode), which is the light on the top, front, right-hand side of the unit. The tables below describe typical status signals and their meanings for the EC9600i and EC9700i series scanners.

Signals in a typical document processing cycle

1. The LED is Green (Solid): The unit is idle.
2. The LED is Green (Flashing): The scanner is waiting for a document to be inserted for scanning.
3. The LED is Green/Red (Flashing): The scanning operation is in progress.
4. The LED is Green (Solid): The scanning operation is complete. The scanner has returned to its idle state.

EC9600i network scanner signals

Status	LED Sequence	Notes
<i>Booting</i>	Solid red (max 30 seconds)	The scanner is starting.
Booting	Long-red and two short-green flashing cycle	
Unconnected	Long-green and short-red flashing cycle	The scanner does not detect an Ethernet or USB connection.
Idle	Long-green and short-green flashing cycle	The scanner is ready and idle. <i>Note: The idle signal depends on your payment application.</i>
Idle	Solid green	
<i>Busy</i>	Green flashing	The scanner is waiting for the user to insert a document into the feeder.
<i>Busy</i>	Solid green	The scanner is waiting for the user to take action on the PC application.
<i>Busy</i>	Green and red flashing cycle	The scanner is processing the documents. Wait for the scanner to finish.
<i>Error</i>	Red flashing	An error occurred while the scanner was processing the document. Check your PC application for instructions or refer to your local procedures. If you need more help, contact your distributor (reseller).

EC9700i network scanner signals

Status	LED Sequence	Notes
Booting	Solid Red (max 10 seconds)	Device is booting up
Unconnected	3 seconds Green / 3 seconds Red	No network connection: device is not connected to a network via Ethernet port or a computer via USB port
Idle	Solid Green (claimed or not claimed)	Device is connected and idle
Busy	Flashing Green (3 seconds on – 3 seconds off)	Operation in progress (scanning, MSR swipe, printing, firmware upgrade), including waiting for item
Error 1	Flashing Red (3 seconds on – 3 Seconds off)	Software has an error
Error 2	Flashing Red (1 seconds on – 1 second off)	Document track has an error

Maintaining your scanner

Removing the covers

RDM network series scanners have two covers that can be removed in order to clean the image sensor, replace cartridges, or clear paper jams.

Front cover

Remove the front cover when you need to clear paper jams, replace the franker cartridge, or clean the image sensor.

1. Disconnect the power cord from the scanner.
2. Pull the insertion extensions forward.
3. Grasp the front and the back end of the front cover.
4. Gently pull the cover upwards until it detaches from the scanner.



To replace the front cover:

Caution: Before you replace the front cover, make sure the insertion extensions are pulled forward. Otherwise, you might damage the front cover.

1. Carefully place the front cover over the scanner assembly. Make sure that the cover overlaps the assembly correctly by lining it up with the metal posts.
2. Gently push the cover down until it snaps into place.

Endorsement printer cover

Remove the endorsement printer cover when you need to clear paper jams, to insert or replace the endorser inkjet printer cartridge, or to clean the image sensor.

1. Grasp the top of the endorsement printer cover.
2. Gently pull the cover upwards until it detaches from the scanner.

To replace the endorsement printer cover:

1. Carefully place the endorsement printer cover over the scanner assembly; make sure that the cover overlaps the assembly correctly.
2. Gently push the cover down until it snaps into place.

Franker and endorser inkjet cartridges



Franker cartridge
Item# 6000-6065



HP C6602A Black
Endorser inkjet cartridge
Item# 6000-6060

The franker cartridge creates a red ink stamp that defaces the front of each check with a message that says “Electronically Presented”. This option is available for the EC9600i scanners only (except EC9611 SMB). Franker cartridges are not included with scanners.

Certain network scanner models are inkjet endorser enabled to spray a user-defined text endorsement message on the rear of the check. Your payment application must also be enabled to support inkjet endorsement. Endorser inkjet cartridges are not included with scanners.

Franker and endorser inkjet cartridges can be purchased through your solution provider or scanner reseller.

Follow the directions below to insert the cartridges into the scanner:

Caution:

- Ink might be harmful if swallowed.
- Avoid contact with eyes.
- Damage to the unit or the cartridge which results from modifying the inkjet cartridge is not the responsibility of RDM.
- The inkjet cartridge is not refillable.
- Inkjet cartridges are not licensed for modifications.
- RDM may change product designs, features, or specifications at any time.

Installing the franker cartridge

1. Remove the front cover of the scanner.

At the back of the scanner, the franker cartridge is held in place by a blue franker latch and a metal plate.

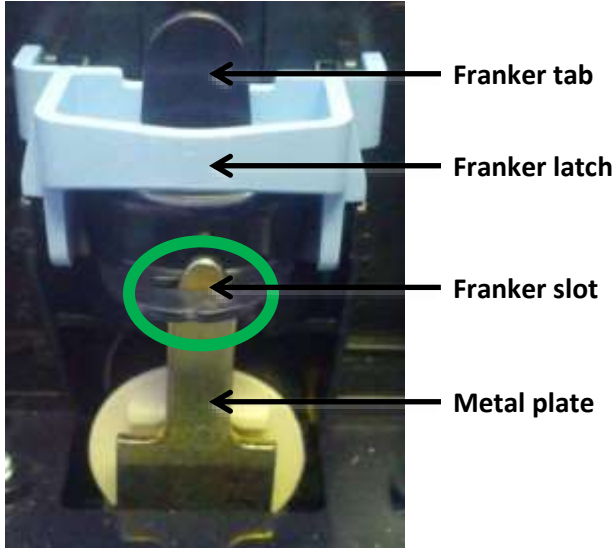

2. Lift the blue franker latch.
3. Pull the franker cartridge out of the scanner by the franker tab.
4. Insert the new franker cartridge. Make sure the top of the metal plate fits into the slot in franker cartridge (as pictured).
5. Secure the franker cartridge:
 - a. Push the metal plate towards the body of the scanner (pushing in the franker cartridge).
 - b. Lowering the blue latch over the franker cartridge until it snaps closed.
6. Replace the scanner cover.

Click to view video: [How to Install the Franker Cartridge](#)

Alternatively visit: <https://www.youtube.com/user/RDMCorporation/playlists>

Installing the endorser inkjet cartridge

When you place the new inkjet cartridge into the holder for the EC9600i series, make sure that you insert it at the angle described in the following steps. If you do not insert the cartridge properly, it might not make contact with the document when it is scanned.

1. Remove the endorsement printer cover.
2. Pull the inkjet latch away from the inkjet cartridge (as pictured).



3. Pull the inkjet cartridge out of the scanner.
4. To insert the new inkjet cartridge, pull the inkjet latch back and place the inkjet cartridge into the holder. The cartridge needs to be at an angle so that the back of the cartridge is lower than the front of the cartridge.
5. Push the cartridge down into the holder until the cartridge snaps into place. Once installed, the inkjet cartridge sits on a slight angle with the back of the cartridge lower than the front.
6. Make sure there is no gap between the inkjet cartridge and the endorsement channel.
7. Replace the endorsement printer cover.



Click to view video: [How to Install the Inkjet Cartridge](#)

Alternatively visit: <https://www.youtube.com/user/RDMCorporation/playlists>

Replacing the inkjet blotter

Scanners with endorsement printers include an inkjet blotter that absorbs excess ink from the endorsement process. Over time, the blotter might stop absorbing ink effectively and so should be replaced. Scanners with endorsement printers come with five replacement blotters.

To replace the inkjet blotter:

1. Remove the front cover of the scanner.
At the back of the scanner, above the franker cartridge, you can see the top of the inkjet blotter, as shown below:
2. With your finger or tweezers, remove the inkjet blotter from its slot.
3. Dispose of the used blotter.
4. Insert the replacement inkjet blotter into the slot.

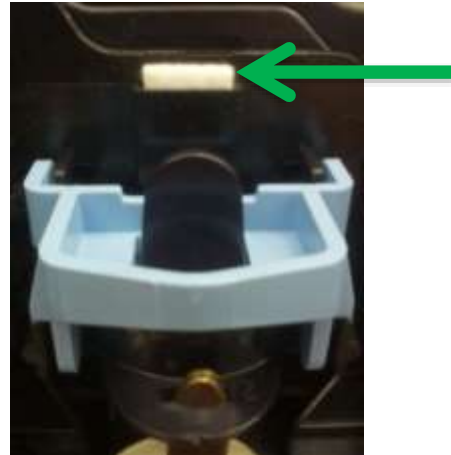

Replacing the paper roll for the printer

If your scanner has a printer, the following steps describe how to replace the paper roll.

1. Press the printer door release button and completely open the printer door.
2. Remove the empty paper roll from the paper compartment.
3. Insert the new paper roll into the compartment, with the end of the paper roll rolling from the top.
4. Pull the paper out of the compartment and close the printer door so that the end of the paper sticks out of the compartment (as pictured). Push the door closed in the center of the printer door.

Make sure the cover is completely closed. If you push the cover from the sides, the cover might not close completely. When closed correctly, both sides of the printer cover are flush with the scanner.

5. Rip off any access paper sticking out of the printer cover.



Cleaning your scanner

RDM recommends that you periodically clean the scanner to remove dust, ink and debris build-up to ensure optimal performance and extended scanner life.

There are two ways to clean your RDM scanner:

1. Using the **RDM ScannerCare Cleaning Kit**, which includes WaffleTechnology™ cleaning cards and device wipes:
 - You can use the RDM ScannerCare application via the RDM Network Scanner Dashboard or your payment application's document feeding cycle as described below.
2. **Manually**, by follow instructions provided in *Manual cleaning* on page 34.

Using RDM ScannerCare Cleaning Kit

Cleaning the scanner using the RDM ScannerCare application

1. You can access the RDM ScannerCare cleaning application through the RDM Network Scanner Dashboard (see page 38):
2. Select the "RDM ScannerCare" page.
3. Select the "Clean scanner" tab.

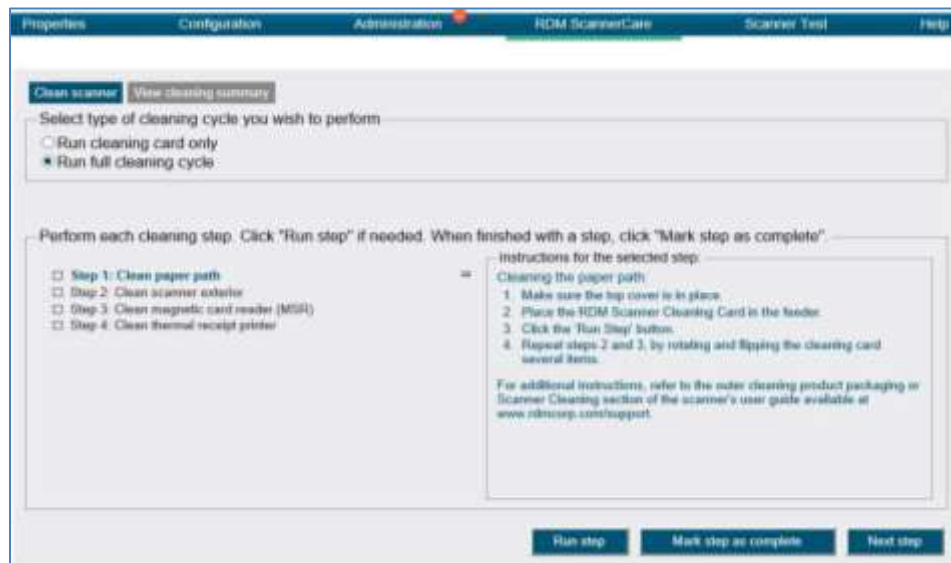

4. Choose to run either the cleaning card only or run a full cleaning cycle.

5. Perform each step. Click on each step as needed and follow the instructions.
 - a. Click the “Run step” button to begin the step.
 - b. When the step is completed, click the “Mark step as complete” button.
 - c. Click on either the next step, or the “Next Step” button to advance to the next step.
 - d. Continue until all steps are completed.
6. Select the “View cleaning summary” tab.
7. View the cleaning summary for the scanner. The summary shows various information related to each scanner cleaning step.

Here is the “View cleaning summary” tab:

Cleaning step	Date last cleaned	Days since last cleaning	Uses since last cleaning	Total number of uses	Total number of cleanings
Clean paper path	2018/01/10	0	0	1981	2
Clean scanner exterior	2018/01/10	0	0	1981	2

Cleaning the scanner with a document feeding application

1. Start your document feeding application.
2. Run the cleaning card through the RDM scanner several times, rotating the card top to bottom on both sides.
3. Cancel the application, discard the used cleaning card.

Manual cleaning

Scanners perform best when all working surfaces are clean and free of foreign material.

Caution:

- Always disconnect the scanner from its power source before manual cleaning.
- Solvents or harsh cleaners might damage or discolor the cabinetry.

Cleaning the outside cabinetry

Use a damp cloth and mild soap.

Cleaning the inside of the scanner unit

1. Remove the front cover and the endorsement printer cover.
2. Use a dusting brush designed for use with electronic equipment or a compressed air duster to clean inside the scanner.
3. Replace the covers.

Cleaning the image sensor

Caution: Always disconnect the unit from its power source before cleaning the image sensor.

1. Remove the front cover and the endorsement printer cover.
2. Open both the front and back panels that cover the image sensor.
The front panel can open up to 90°. The back panel opens only a few degrees.
3. Use any of the following to gently remove any ink or dust from the image sensor.
 - A lens cleaning tissue.
 - A damp lint-free cloth.
 - A cotton swab dampened with rubbing alcohol.
4. Clean the glass on each panel thoroughly.
5. Replace each of the covers.



Troubleshooting

During everyday operations, you might encounter minor malfunctions with RDM EC9600i and EC9700i series network scanners. Before calling for service, review the troubleshooting steps below.

Scanner does not respond

1. Ensure the cable that connects your scanner to your computer is properly connected to the correct port on the back of the scanner and computer (according to instructions provided by your reseller).
2. Make sure that the correct power cord is connected to the unit. If your power cord has an on/off switch, make sure the switch is in the “on” position. Change or replace the cord, if necessary.
3. If the problem persists, contact your solution provider or help desk.

Card transactions do not function properly

1. Ensure that you are swiping the card properly.
The black magnetic stripe on the back of the card must face downward and towards the body of the scanner.
2. Try using another card to ensure the first card was not defective.
3. If the problem persists, contact your solution provider or help desk.

Printer does not print

1. Ensure you are using 3” Thermal printer roll (see 44)
2. Ensure that the printer has not jammed.
3. Ensure that the end of the paper, rolls from the top of the roll as shown.
4. Ensure that the printer door is completely closed.
5. If the problem persists, contact your solution provider or help desk.



Can't connect to network scanner

If your payment application cannot connect to the network scanner, try the following troubleshooting steps:

- Make sure the scanner is connected to a power source and to your computer or network. The status LED light should be solid green.
- Your payment application might require that you install security certificates to use the scanner. Make sure that you have installed these certificates. See your payment application's documentation for how to install the certificates or contact your application provider.
- If your payment application uses your internet browser, it might require that you make changes to the browser's security settings. See your payment application's documentation for how to configure your browser.
- If you're using a network connection and there are multiple network connections in your work area (for example, Ethernet cables or Ethernet wall jacks), try connecting the scanner to another connection.
- Try to access the RDM Network Scanner Dashboard (see page 38).

If you can open the scanner dashboard, then your computer can connect to the scanner, but something is preventing your payment application from connecting to it. This situation typically indicates that you need to install security certificates or configure your browser's security settings. To confirm that you have installed certificates and configured your browser, see the documentation for your payment application.

Network Scanner Dashboard

You can use the Network Scanner Dashboard to configure, clean and troubleshoot the scanner.

Click to view video: [Network Scanner Dashboard](#)

Alternatively visit: <https://www.youtube.com/user/RDMCorporation>

To access the RDM Network Scanner Dashboard:

1. Open a browser (Internet connection required)
 - a. **For USB connections:**
 - i. In the URL address bar, enter: **`https://usb.rdm scanners.net`**
 - ii. Alternatively enter:
 - On Windows: **`https://rd<scannerserialnumber>`**
 - On Macintosh: **`https://rd<scannerserialnumber>.local`**
 - For example, **`https://rd3005069611030.local (for Mac)`**
 - b. **For Ethernet connections:**
 - i. In the URL address bar, enter:
 - On Windows: **`https://rd<scannerserialnumber>`**
 - On Macintosh: **`https://rd<scannerserialnumber>.local`**
 - For example, **`https://rd3005069611030.local (for Mac)`**

If you can't open the Dashboard, then you might need to have your network add the scanner to the network by:

- Using the scanner's MAC address (located on the bottom or back of the scanner)
- The scanner's device name is `rd<scannerserialnumber>`. For example, `rd3005069611030`.
 - The serial number is printed on the bottom or back of your scanner, depending on the model.

Below is a screen shot of the Dashboard:



The screenshot shows a web interface with a navigation bar at the top containing tabs for Properties, Configuration, Administration, RDM ScannerCare, Scanner Test, and Help. The main content area displays the following information:

Model	EC9611 [+]
S/N	3005069611030
Scanner Firmware Version	1.2.1.280 [+]
Operation Status	Not Claimed
System	
Uptime	0 hours, 3 minutes, 43 seconds
CPU Usage (user/ sys/ idle/ wait)	1.50/ 5.27/ 93.21/ 0.00
Total/Free RAM Memory	120468K/ 95968K
Total/Free Flash Memory	102300K/ 61588K
Network	
MAC Address	00:0f:10:00:cf:f4
Link Status	Down
IP Type	
IP Address	
Subnet Mask	
Gateway	
DNS	
MTU	1500
Statistics	
Document Count	026
Endorsement Dot Count	001

The dashboard is broken up into multiple pages that allow you to view information about the network scanner and modify its settings:

- **Properties:** Lists information about the scanner and its network configuration. This page is useful when troubleshooting the scanner.
- **Configuration:** Allows you to adjust the scanner's date and time and network settings.
- **Administration:** Allows you to upgrade the scanner's firmware, reboot the scanner, and change the administrator password.
- **RDM ScannerCare:** Instructs you on how to clean your scanner using the RDM ScannerCare Cleaning Kit.
- **Test Scanner:** Allows you to test the features of the network scanner. These tests can be useful if you need to troubleshoot the scanner or a specific feature of the scanner.
- **Help:** Lists detailed information about the other pages and their options.

The Configuration and Administration pages require a username and password to access. The defaults are:

- **Username:** administrator
- **Password:** rdm123

Testing the network scanner

The Test Scanner page of the network scanner dashboard allows you to test the features of the RDM network scanners. The available tests depend on the available features on your model of scanner.

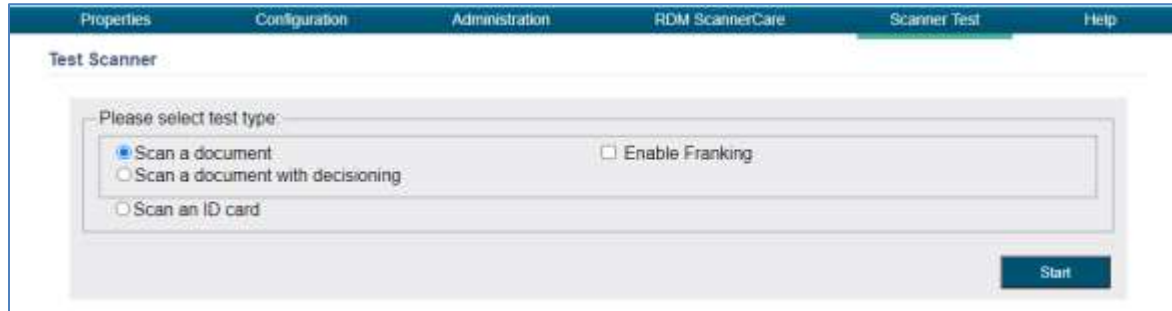

The tests can include:

- **Scan a document:** Tests the scanner's ability to scan an item in single feed mode, capture the front and back of the item, and read the MICR line. To test
- **Scan a document with decisioning:** Tests the scanner's ability to scan an item in single feed mode, capture the front and back of the item, and read the MICR line. You are also prompted to accept or reject the item.
- **Scan documents in batch mode:** Tests the scanner's ability to scan a batch of items in an auto-feed scanning mode, capture the front and back of the items, and read the MICR lines.
- **Scan an ID card:** Tests the scanner's ability to scan and read ID cards, such as a driver's license.
- **Read MSR stripe:** Tests the scanner's ability to read a card with a magnetic stripe. After the test, the information contained in the magnetic stripe displays.
- **Print sample receipt:** Tests the scanner's ability to print receipts.

After scanning a document, ID card, or MSR stripe, a dialog appears with information about what was scanned. For example, after scanning a check, the following dialog appears:

This dialog includes front and back images of the document, an IRN, and the MICR number.

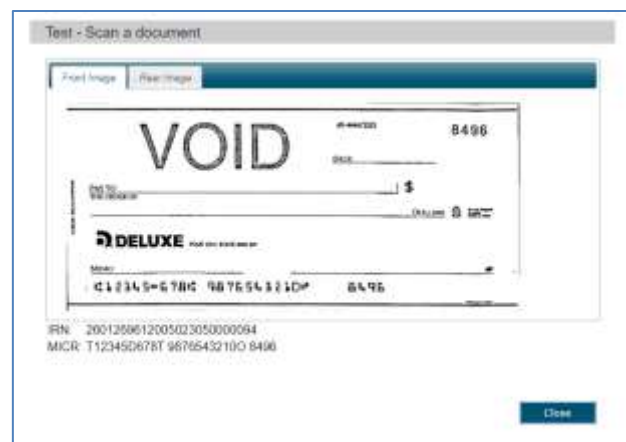

Restoring factory default settings

The RDM network series scanners have a reset button in the back-right corner of the scanner. The reset button restores the dashboard settings to their factory default. The reset button does not affect the firmware installed on the scanner.

To restore the scanner's default settings:

1. Unplug the scanner.
2. Use a pin to hold down the reset button and plug in the scanner.

The scanner starts with the factory default dashboard settings.



After you restore the scanner's default settings:

- If you made changes to the dashboard settings to allow the scanner to work on your network, you will need to make these changes again.
- The password used to access the Configuration, Administration, and Test Scanner pages is reset to its default (rdm123)

Specifications

Physical Dimensions		
Depth: Min: 237mm (9.3") <i>(with retracted extensions)</i> Max: 311mm (12.25") <i>(with fixed extensions)</i>	Width: Standard Models: 154mm (6.0") MSR Models: 157mm (6.2")	Height: EC9600i: Standard Models: 175mm (6.9") Receipt Printer Models: 245mm (9.65") EC9700i: Standard Models: 201mm (7.9") Receipt Printer Models: 245mm (9.65")
Document Feed Capacities		
Preferred paper weight: 20 lb. to 32 lb.	Height: Min: 50.8mm (2") Max: 101.6mm (4")	Length: Min: 101.6mm (4") Max: 228.6mm (9")
Single-feed models	EC9611 SMB/EC9611/12/13	Single Document
Auto-feed models (multi-feed)	EC9603/04/08 EC9703/04/08	Up to 30 documents Up to 60 documents (based on document thickness & condition)
Document collection pocket	Up to 60 documents. (based on document thickness & condition) Maintains the integrity of the order of the original source documents.	
Technical Features		
MICR reader	E13B or CMC7 MICR Fonts. OCR E13B MICR Assist available. Uses RDM's Progressive MICR Method for optimum MICR read accuracy (except EC9611 SMB models which uses optical recognition for E13B characters only. CMC-7 is not available on EC9611 SMB	
Image capture	Duplex imaging. File formats: Tiff 6.0, JPEG, BMP (uncompressed). File compression: JPEG for color (RGB) and grayscale (Quality 25), CCITT Group 4 (ITU T.6) (or no compression) for bi-level. EC9600i documents and ID cards: 100 or 200 DPI grayscale or bi-level EC9700i documents: 200 or 300 DPI grayscale. EC9700i ID cards: 300 or 600 DPI color or grayscale.	
Image processing	EC9600i: Up to 4 images, any combination, front and back for documents or ID cards. Resolutions for documents: 100, 200 DPI grayscale or bi-level Resolutions for ID cards: 200 or 400 DPI image resolution. (V-scan captured at 200DPI) EC9700i: Up to 6 images, any combination, front and back for documents or ID cards. Resolutions for documents: 100, 200, 300 DPI grayscale or bi-level Resolutions for ID cards: 300 or 600 DPI color, grayscale or bi-level	
Identification (ID) card imager	Integrated Duplex Imaging. 54mm [2.13"] (V) x 86mm [3.39"] (H)	
Image Quality Assurance (IQA)	IQA includes too light/too dark /skew (Bi-Level Images Only).	

Magnetic Stripe Reader (MSR) <i>(select models)</i>	Integrated 3-track, bi-directional, alphanumeric, encryption capable MSR.												
Optical character recognition	OCR recognition can be performed under application control as follows: EC9600i: Alphanumeric OCR A & B – optional license required EC9700i: Alphanumeric OCR A & B and 2D barcode (PDF417) optional												
Franker	Under application control a fixed text message “Electronically Presented” can be stamped on the front of a document, in red ink for EC9600i series only.												
Inkjet endorsement printer	Under application control, a single line 1/8” high text message can be printed on the rear of a document. HP C6602A inkjet cartridge required.												
Scanner status LED	Provides the unit’s status via illuminated LED.												
USB port	High Speed USB 2.0 (480 mbps) on all models.												
Ethernet ports	Ethernet Port Configuration EC9600i: max. network speed of 10/100 mbps EC9700i: max. network speed of 10/100/1000 mbps <table border="1"> <thead> <tr> <th><u>Model type</u></th> <th><u>EC9600i</u></th> <th><u>EC9700i</u></th> </tr> </thead> <tbody> <tr> <td>Single-feed (SMB)</td> <td>n/a</td> <td>n/a</td> </tr> <tr> <td>Single-feed (SF)</td> <td>1</td> <td>n/a</td> </tr> <tr> <td>Auto-feed (AF)</td> <td>2</td> <td>1</td> </tr> </tbody> </table>	<u>Model type</u>	<u>EC9600i</u>	<u>EC9700i</u>	Single-feed (SMB)	n/a	n/a	Single-feed (SF)	1	n/a	Auto-feed (AF)	2	1
<u>Model type</u>	<u>EC9600i</u>	<u>EC9700i</u>											
Single-feed (SMB)	n/a	n/a											
Single-feed (SF)	1	n/a											
Auto-feed (AF)	2	1											
Receipt printer <i>(select models)</i>	Integrated 3” thermal receipt printer. Clamshell paper load. Paper width 80mm (3.15”). Print width 71mm (2.8”). Maximum print speed of 170mm/sec (6.7”/sec). Uses power from scanner’s power supply.												
Software and Support													
Supported browsers	Internet Explorer, Edge, Chrome, Firefox and Safari.												
System environments <i>(Ethernet connected)</i>	Virtual desktop/thin client (e.g. Citrix) and Virtual machine (e.g. VMware Horizon) environments.												
Development software	RDM Network Scanner Developer Package. Includes RDM SCI API components and sample applications.												
3rd party certifications / licenses	Silver Bullet Technologies Ranger™ Remote (embedded). Requires Ranger licensed models												
Environment													
Operating temperature	10 to 40 Degrees C (50 to 104 Degrees F).												
Operating humidity	10 to 85% relative humidity (non-condensing).												
Power Rating													
Unit input (24VDC)	Standard Models: 1.5A. Receipt Printer Models: 2.5A.												
Power supply input range	100–240V, 50/60 Hz.												

Other	
Certifications	IEC 62368-1 (Product Safety) For EC9700i IEC 60950-1 (Product Safety) For EC9600i FCC Part 15, Subpart B, Class A - Unintentional Radiators (EMC)
Warranty	2-year standard warranty.
Life expectancy	5 years under normal usage.
Consumables and Accessories	
	RDM part number
Replacement franker cartridge – “Electronically Presented” red ink <i>(sold separately)</i>	6000-6065
Replacement HP inkjet printer cartridge <i>(sold separately)</i>	6000-6060 (HP C6602A) – black ink
Ink Jet Blotter - 5 pack	302987
Thermal paper roll 3.125" W x 225' L (3.125" maximum diameter)	Standard thermal roll paper available from office supply stores
Replacement power adapter and cord	EC9600i bundle: 302843 - standard models. 303811 – receipt printer models. EC9700i individual: 303986 - power supply. 303988 - power cord.
USB 2.0 cable , A to B male, shielded, 2m (black)	6000-6106
Ethernet cable , Cat5E RJ45 350MHZ, 1.5m (black)	6000-6114

Warranty Information

LIMITED WARRANTY:

RDM network series scanners are warranted against defects in materials and workmanship under normal use and service for a period of two years after the date of receipt by you. This warranty is extended only to the original purchaser. Extended warranty programs might be offered by your solution provider.

The entire liability of RDM Corporation (the Corporation), distributors of the RDM network scanners and manufacturers of auxiliary equipment used with the RDM network scanners and your exclusive remedy shall be, at the Corporation's option either (a) return of the price paid, or (b) repair or replacement of the RDM network scanners that does not meet the limited warranty and which is returned to the Corporation with a purchase receipt or other proof of date of original purchase which will be required in order to exercise your rights under this warranty.

The limited warranty is void if failure of the RDM network scanners has resulted from accident, abuse or misapplication. Any replacement RDM network scanners will be warranted for the remainder of the original warranty period.

The equipment is sold with the understanding that neither the Corporation, such distributors nor such manufacturers will be liable for any damages whatsoever (include, without limitation, direct or indirect damages for personal injury, loss of business profits, business interruption, loss of business information, or any other pecuniary loss) arising out of the use of or inability to use the RDM network scanners, even if the Corporation, such distributors and/or such manufacturers have been advised of the possibility of such damages.

In any case, the entire liability of the Corporation, such distributors and such manufacturers with respect to the RDM network scanners shall be limited to the amount actually paid by you for the RDM network scanners. The Corporation, such distributors and such manufacturers disclaim all other warranties, express or implied, including, without limitation, implied warranties of merchantability and fitness for a particular purpose with regard to the RDM network scanners and the accompanying written materials.

WARRANTY SPECIFICS:

This warranty only covers failures due to defects in materials or workmanship, which occur during normal use.

It does not cover the following:

- Damage, which occurs in shipment;
- Failures which are caused by products not supplied by RDM;
- Failures which result from accident, misuse, abuse, neglect, excessive dirt or dust cause by lack or preventative maintenance measures, mishandling, misapplication, alteration or modification;
- Service by anyone other than RDM;
- Damage that is attributable to acts of nature including but not limited to:
 - Flood, lightning, power surge or static electricity, water damage, fall, theft, or vandalism;
 - Spillage of liquid or objects that have fallen into the equipment;
 - Equipment that has been exposed to excessive heat or unstable environmental conditions;
 - Consumables such as Franker Roller or Franker Assembly, or other RDM network scanners consumables or accessories such as cables.

RDM scanner units with problems found to be caused by incorrectly set configuration parameters are not considered defective and will not be serviced under warranty.

Warranty is void if any of the external case of the unit has been opened or removed or the unit has, in RDM's opinion, been damaged through misuse or improper care.

Units returned to RDM for warranty repair will be reconfigured with factory defaults and returned to customers.

RDM and its authorized service depots reserve the right to charge a fee for scanners found to be problem free "No Trouble Found".